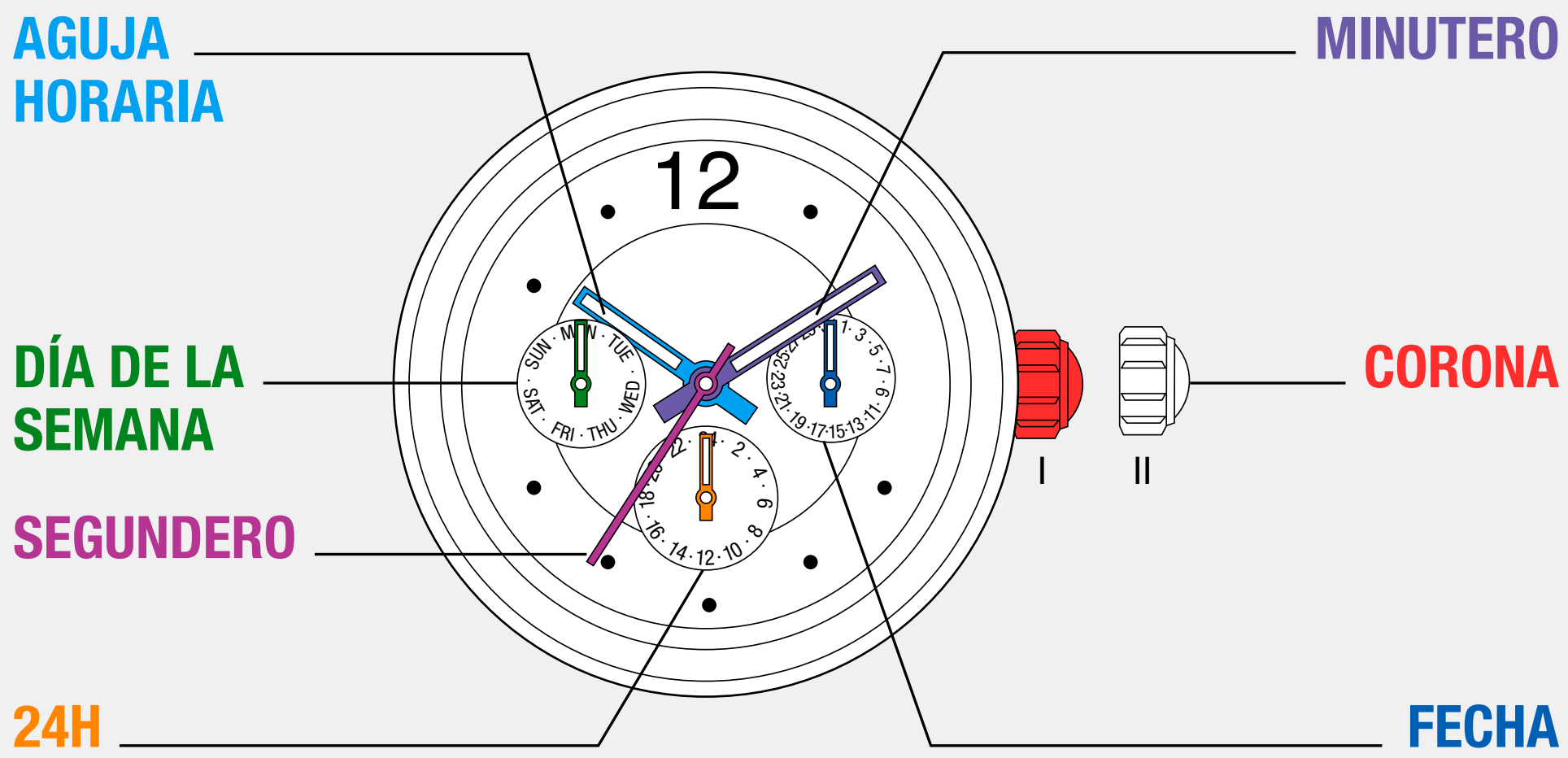
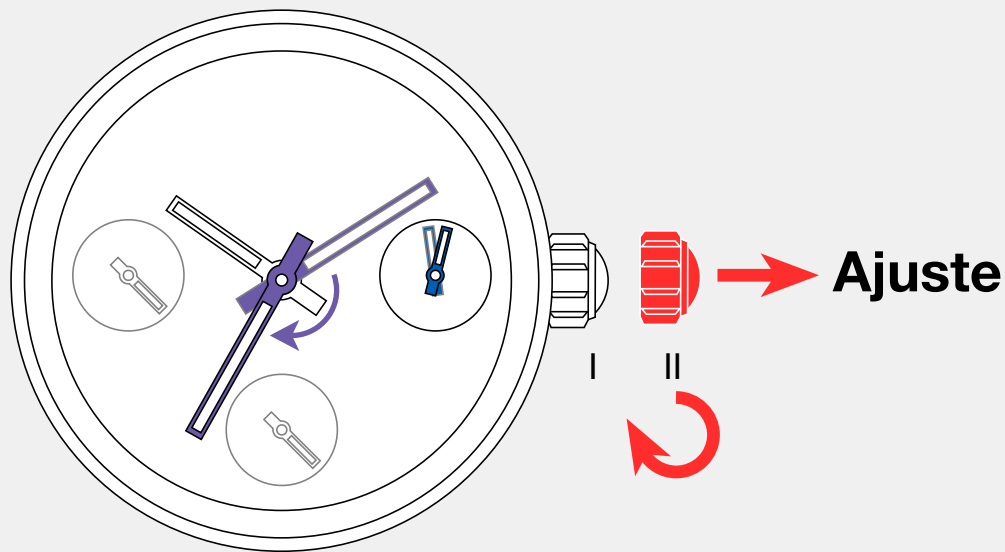
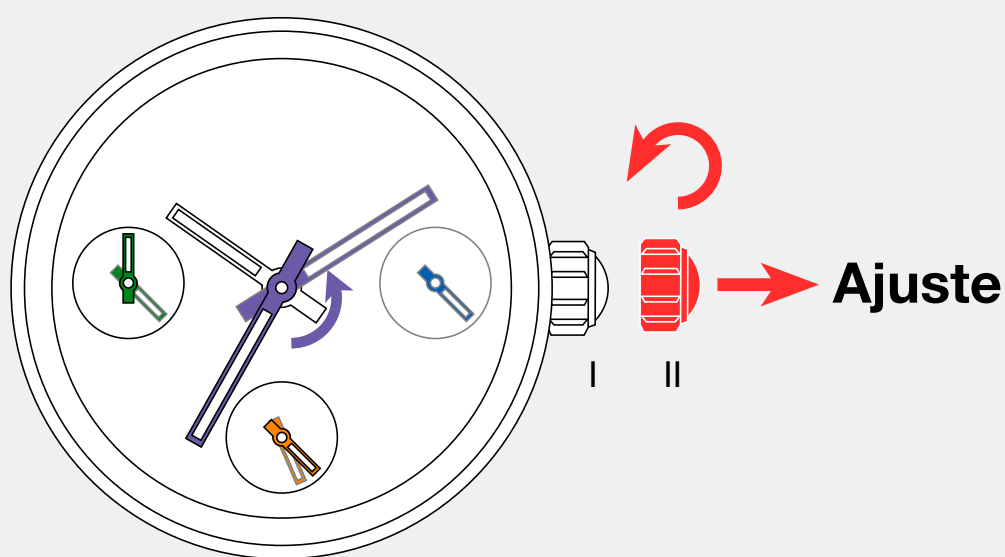

**PRESENTACIÓN****SINCRONIZAR EL DÍA Y LA FECHA****1 AJUSTE DE LA FECHA**

Tirar de la corona y colocarla en pos. II  
Girar la corona en sentido de las agujas del reloj para ajustar la fecha deseada

**Comentario:** La fecha no cambia en el otro sentido. De forma que cuando la fecha cambia es posible hacer un desplazamiento completo entre las 22h y las 2h hasta que se alcanza la fecha deseada.

**2 AJUSTE DEL DÍA**

Girar la corona en el sentido contrario a las agujas del reloj para ajustar el día deseado.

**Aviso:** Respetar el contador de 24 horas si la hora es de mañana o de tarde. En caso de no disponer del contador de 24 horas, es posible identificar la hora de mañana o de tarde mediante el salto de día. Hora de mañana o de tarde con el salto de día.

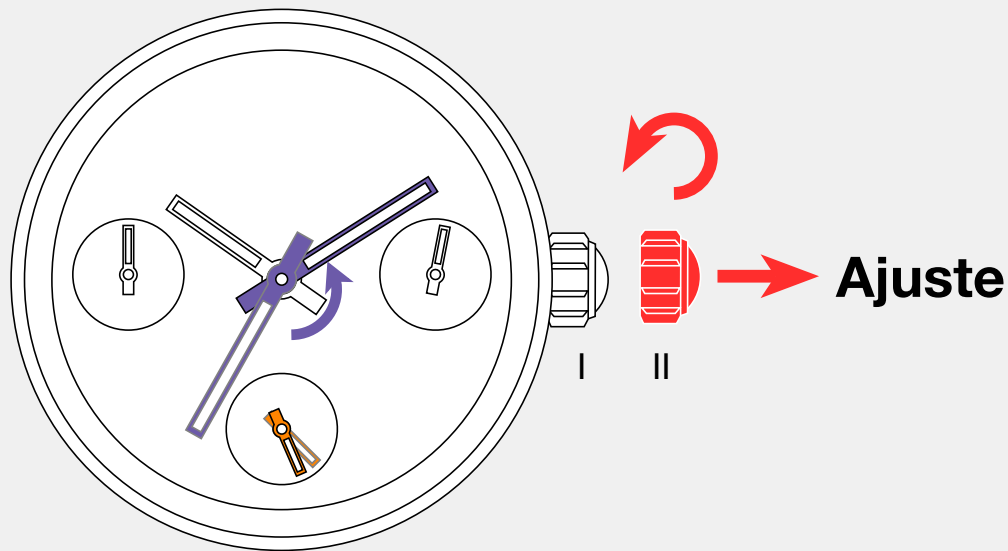
**3 AJUSTE DE HORA Y 24 H.**

Girar la corona en el sentido contrario a las agujas del reloj para ajustar la hora deseada.

**Comentario:** Si no desea cambiar el día o la fecha, solo debe efectuarse un giro (12 horas).

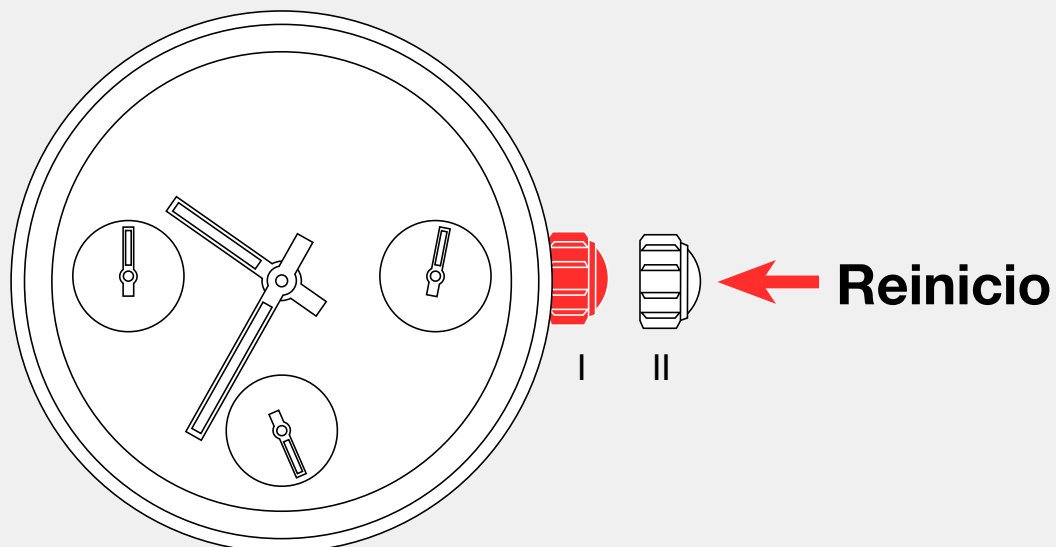
**4**

Empujar la corona hacia pos. I

## EJEMPLO: Viernes 30 -&gt; Sábado 1

①

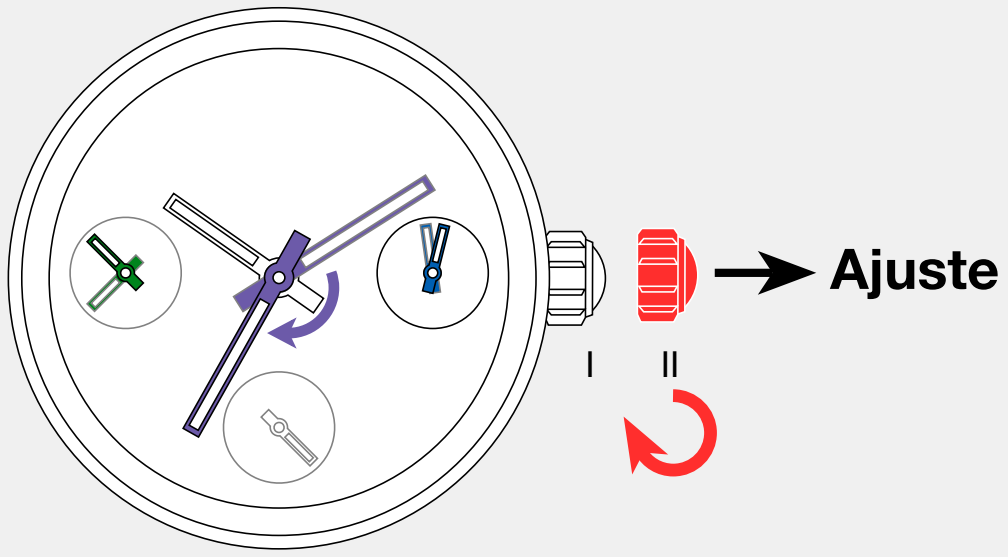

Tirar de la corona a pos. II.

Es viernes 30.

Girar la corona en el sentido de las agujas del reloj (2x24h) para ajustar la fecha al día 1. Normalmente, el día es domingo.

②

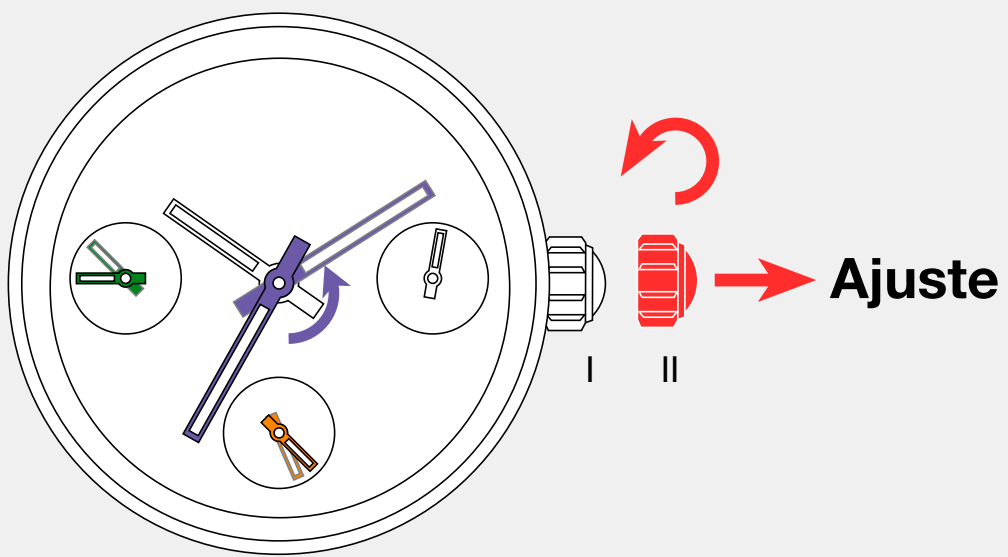

Hoy es domingo 1.

Girar la corona en el sentido contrario a las agujas del reloj (1x24h) para ajustar el día a sábado.

**Comentario:** La fecha no cambia en el sentido contrario a las agujas del reloj.

**Aviso:** Respetar el contador de 24 horas si la hora es de mañana o de tarde. En caso de no disponer del contador de 24 horas, es posible identificar la hora de mañana o de tarde mediante el salto de día.

③

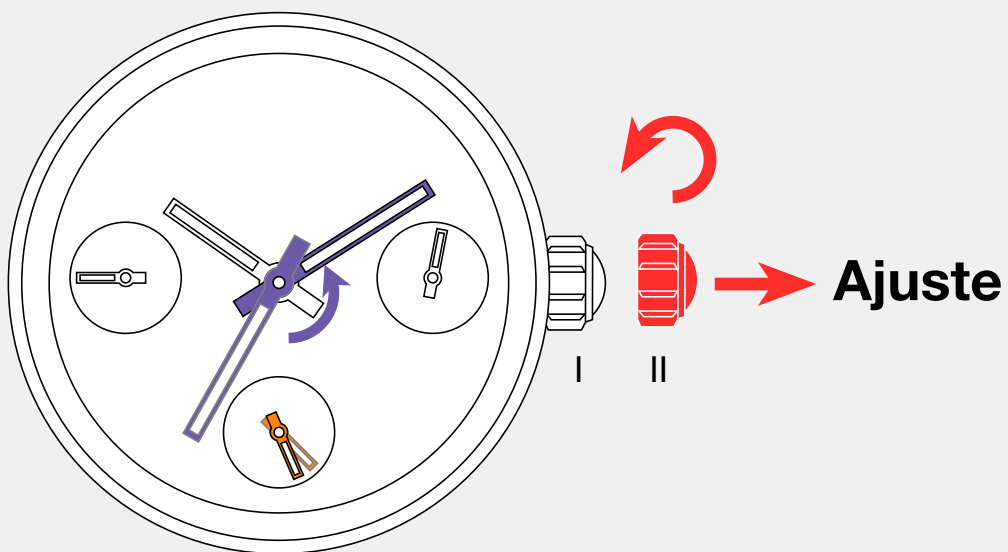

Girar la corona en el sentido contrario a las agujas del reloj para ajustar la hora deseada.

**Comentario:** Si no desea cambiar el día o la fecha, solo debe efectuarse un giro (12 horas).

④

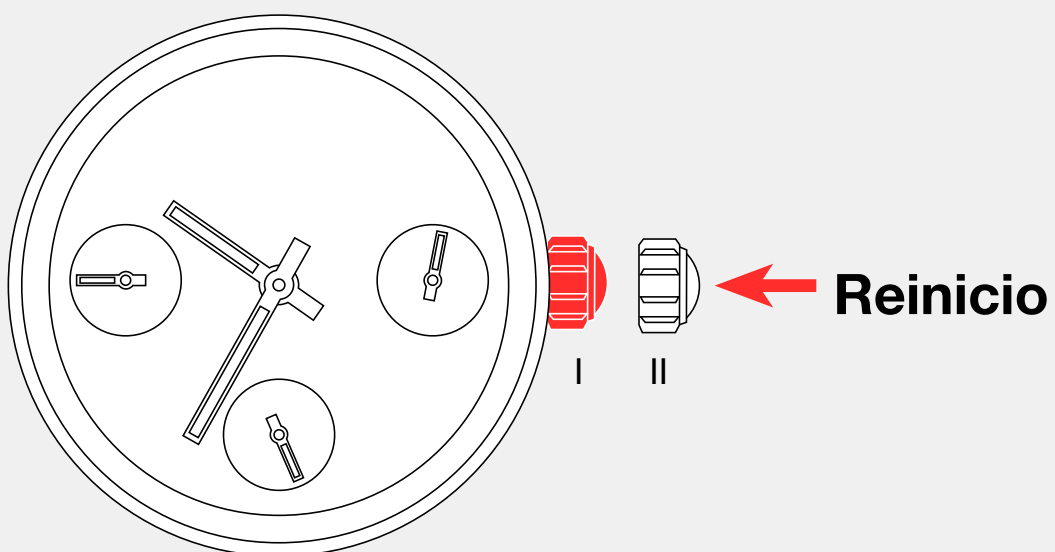

Empujar la corona hacia pos. I



## AJUSTE DE LA HORA Y MINUTOS

1

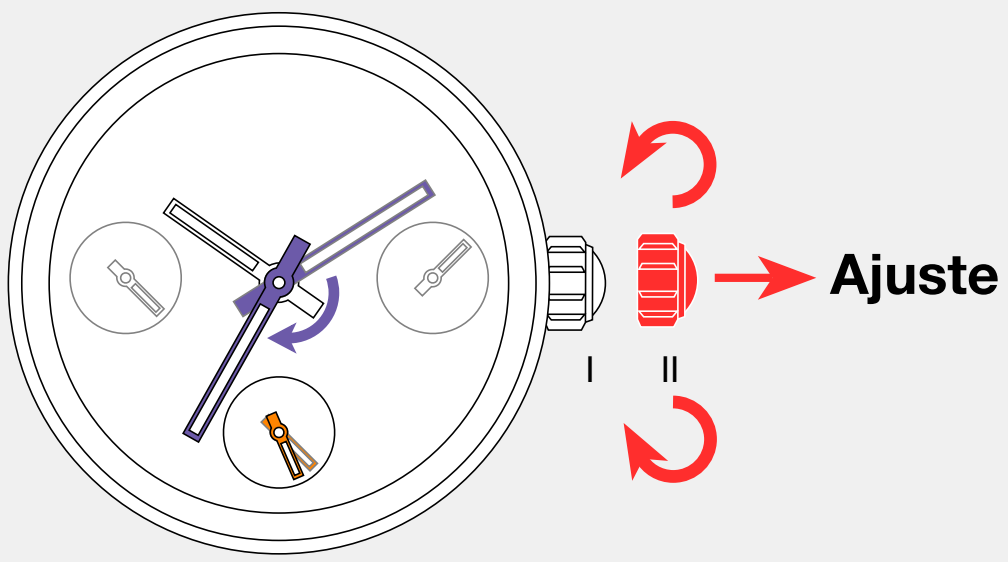

Tirar de la corona y colocarla en pos. II

**Aviso:** Respetar el contador de 24 horas si la hora es de mañana o de tarde.

2

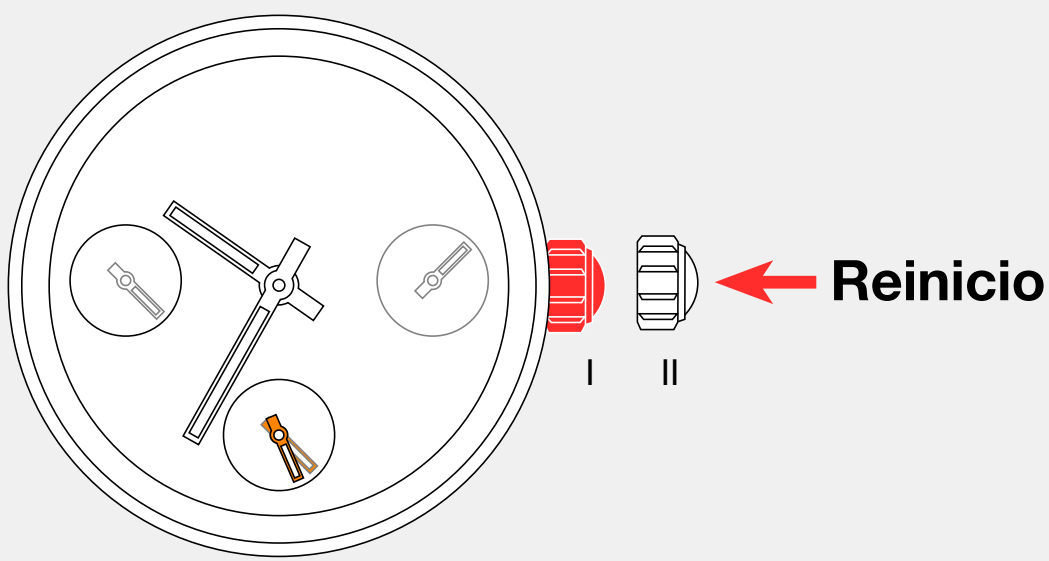

Empujar la corona hacia pos. I

**Comentario:** Si no dispone de un contador de 24 horas, es posible identificar la hora de mañana o de tarde mediante el salto de fecha o de día.

## AJUSTE DE LA FECHA

1

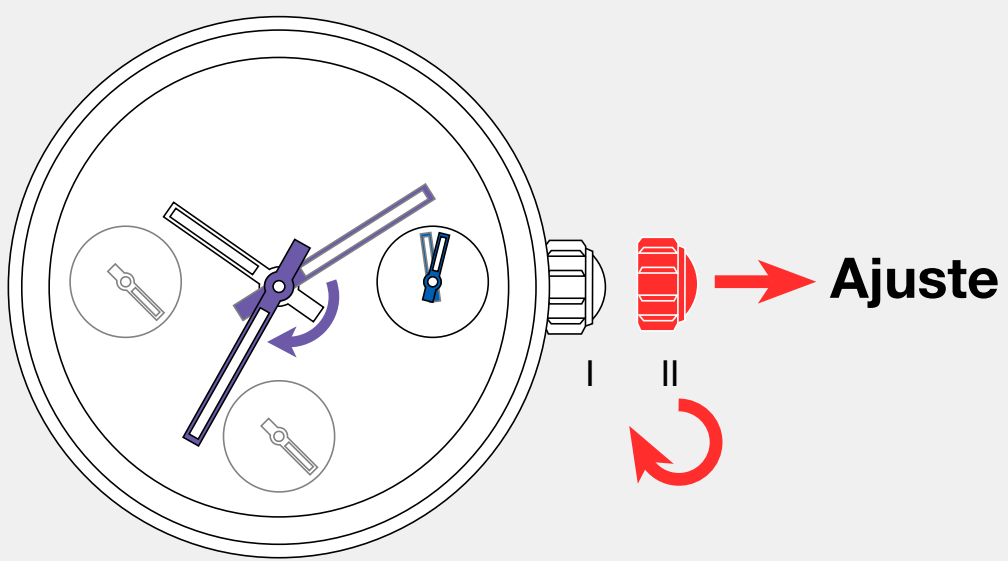

Tirar de la corona y colocarla en pos. II

2

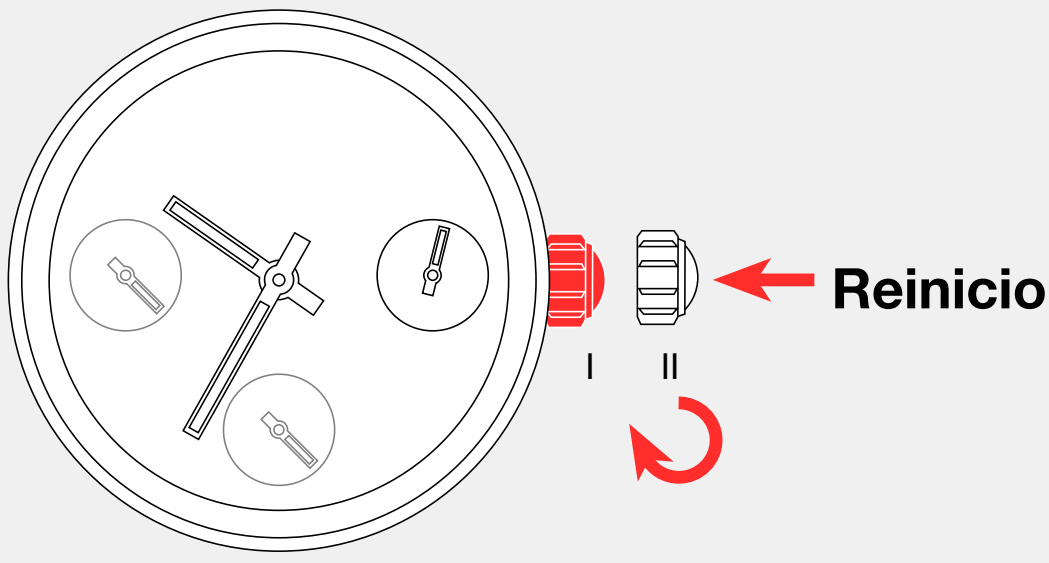

Empujar la corona hacia pos. I



## PRESENTATION

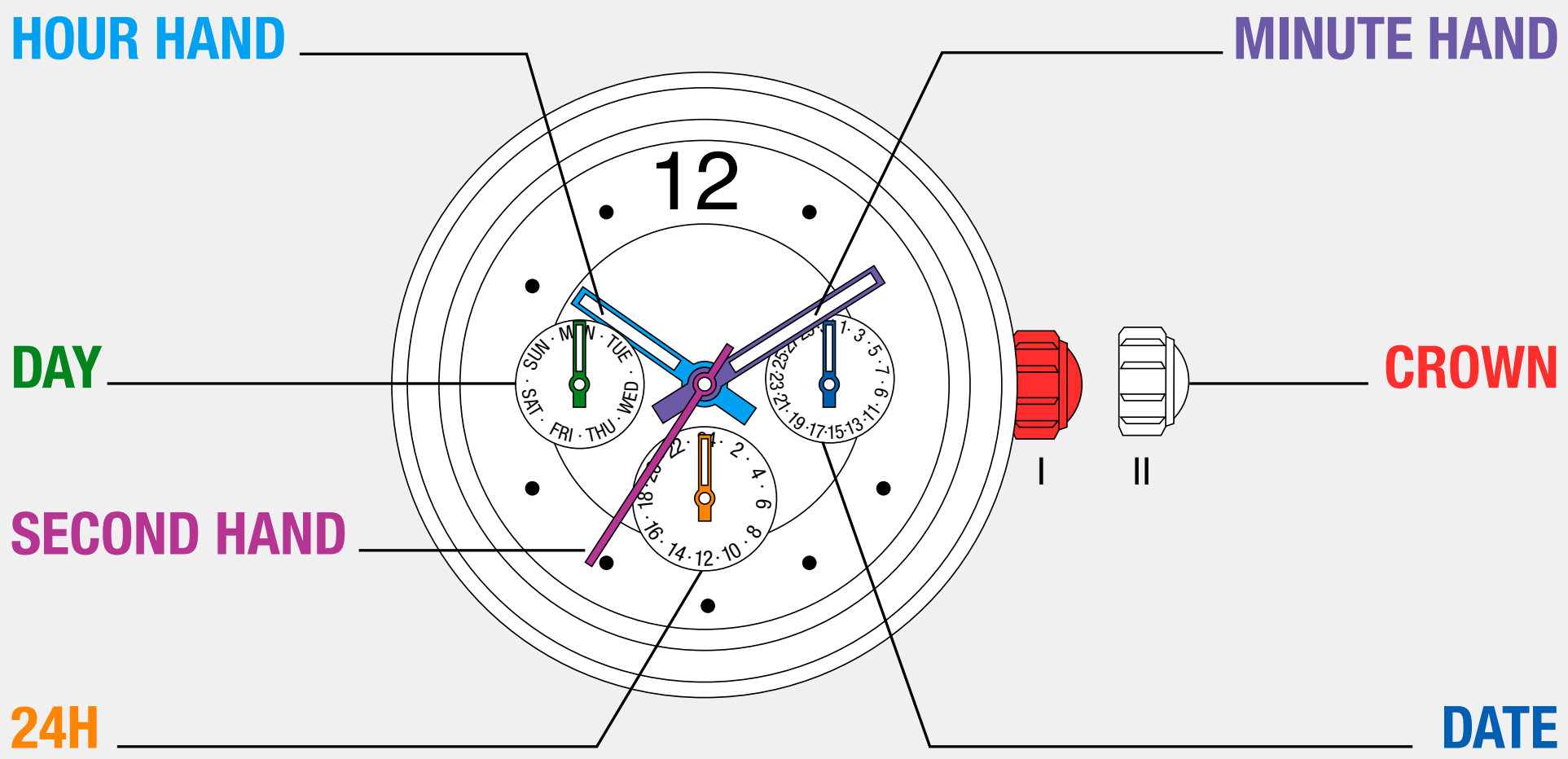

## SYNCHRONIZE THE DAY AND THE DATE

### ① Setting date

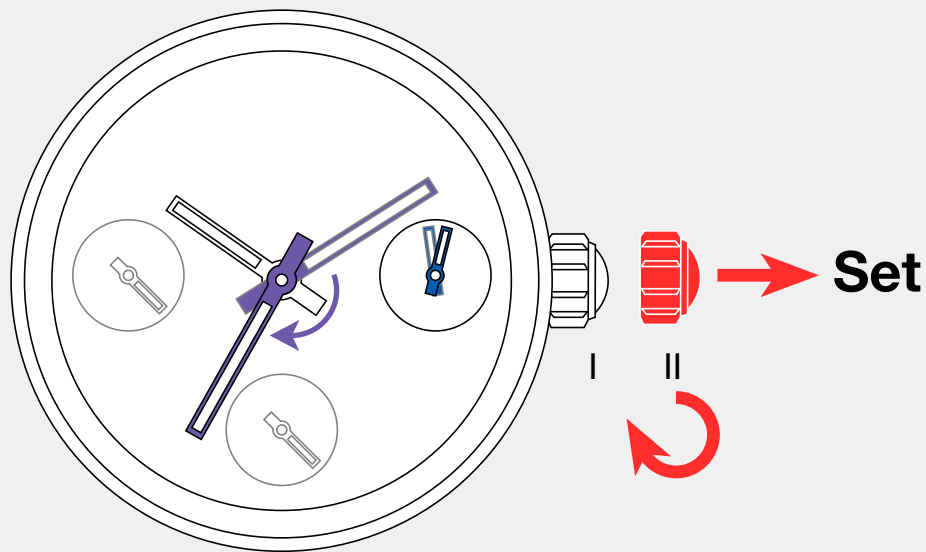

Pull the stem in pos. II

Turn the crown in the clockwise direction to adjust the desired date.

**Comment:** The date doesn't change in the other direction. So, when the date jumped you can do round trip between 22h and 2h until the desired date.

### ② Setting day

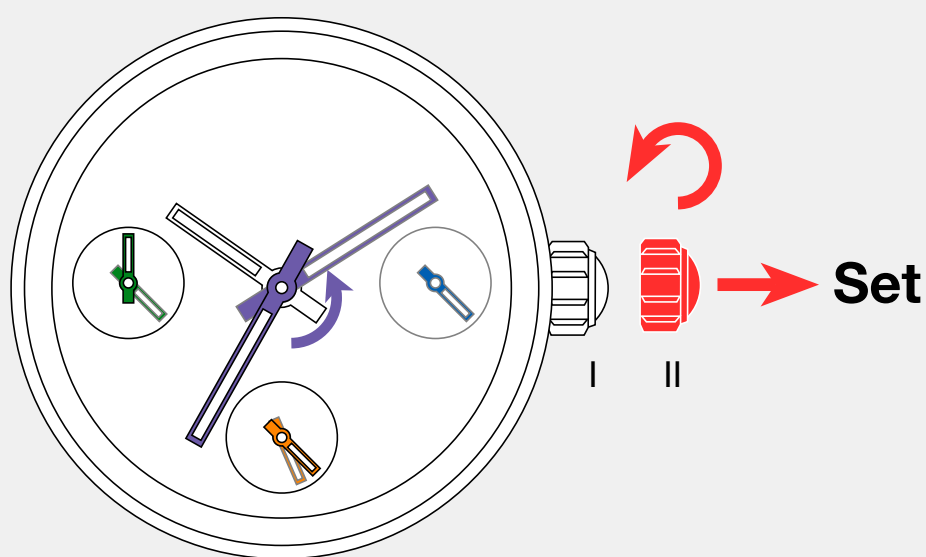

Turn the crown in the counter-clockwise direction to adjust the desired day.

**Warning:** Respect on the counter 24h if you are AM or PM. If you don't have the counter 24h, you can identify the AM or PM with the day jump. AM or PM with the day jump.

### ③ Setting hour and 24h

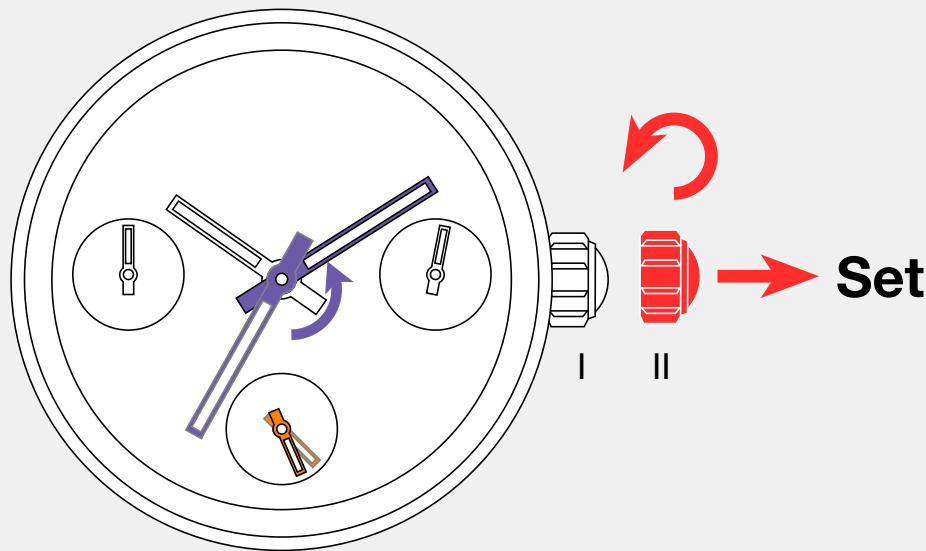

Turn the crown in the counter-clockwise direction to adjust the desired hour.

**Comment:** Only 1 turn (12h) has to be respected if you don't want to change the day or the date.

### ④

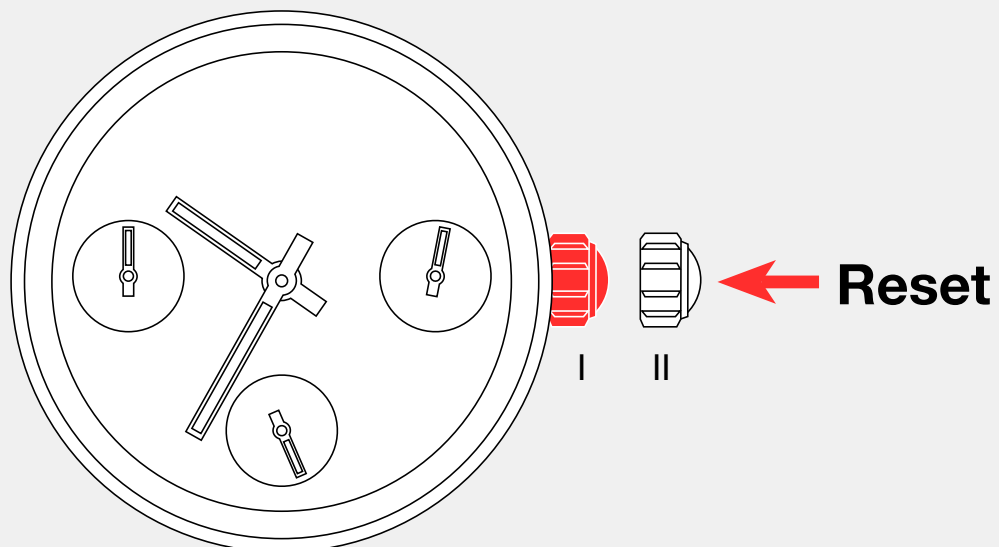

Push the stem in pos. I

## EXAMPLE Friday 30th -> Saturday 1st

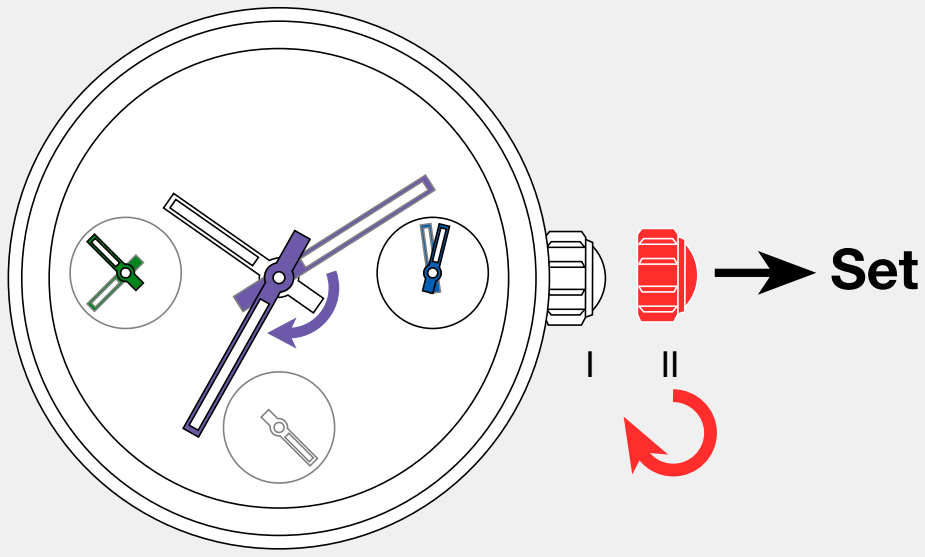
**1**

Pull the stem in pos. II

We are friday 30th.

Turn the crown in the clockwise direction (2x24h) to adjust the date at 1st.

The day is normally at sunday.

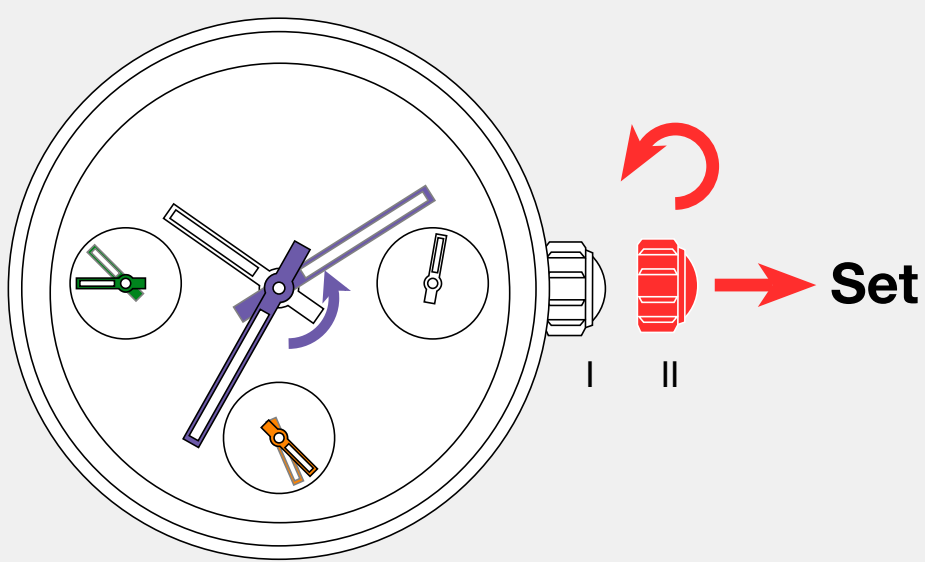
**2**

We are sunday 1st.

Turn the crown in the counter-clockwise direction (1x24h) to adjust the day at saturday.

**Comment:** *The date doesn't change in the counter-clockwise direction.*

**Warning:** *Respect on the counter 24h if you are AM or PM. If you don't have the counter 24h, you can identify the AM or PM with the day jump.*

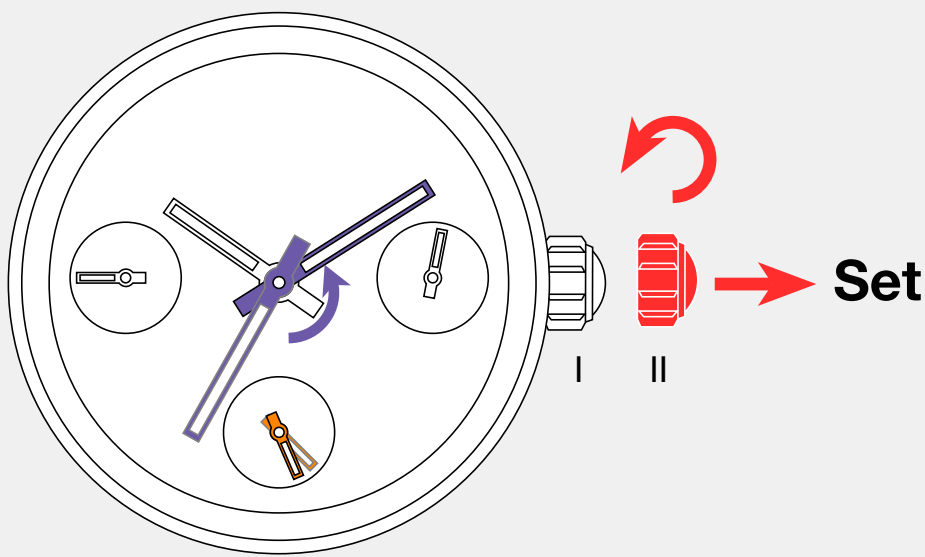
**3**

Turn the crown in the counter-clockwise direction to adjust the desired hour.

**Comment:** *Only 1 turn (12h) has to be respected not to change the day or the date.*

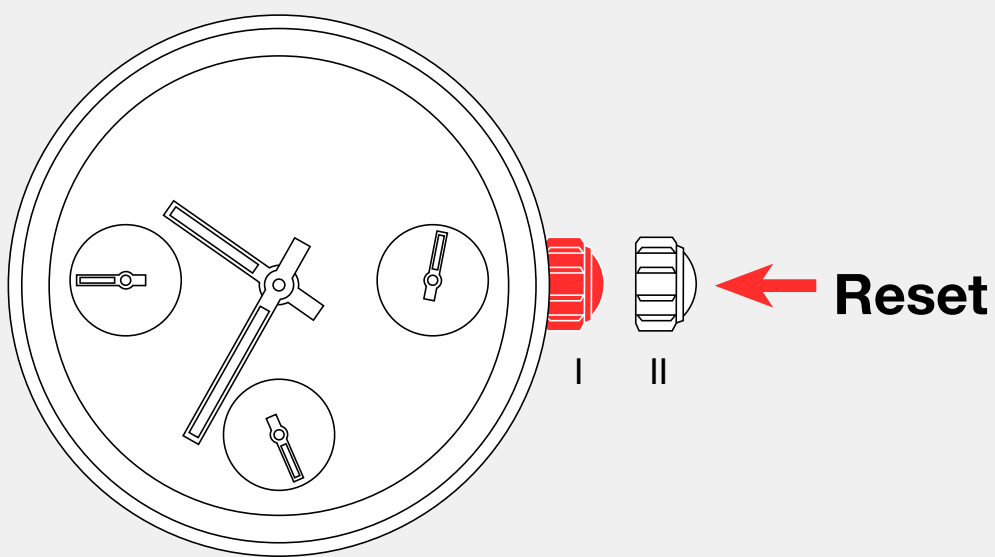
**4**

Push the stem in pos. I

## SETTING THE TIME HOUR AND MINUTE

①

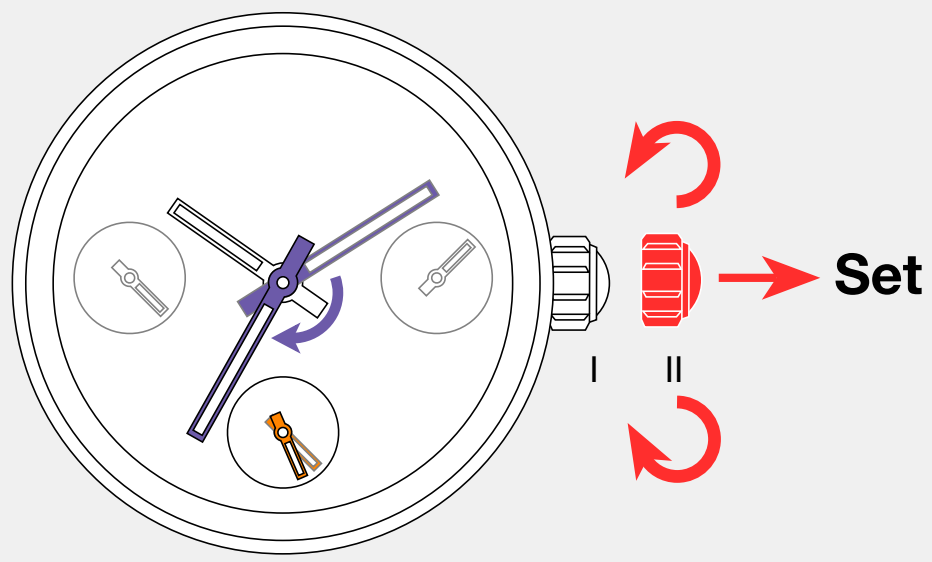

Pull the stem in pos. II

**Warning:** *Respect on the counter 24h if you are AM or PM.*

②

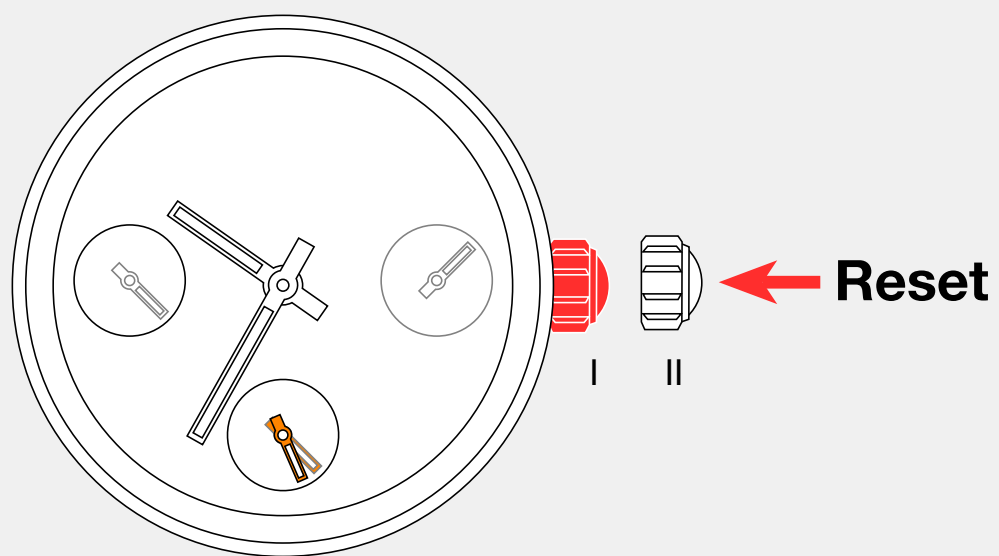

Push the stem in pos. I

**Comment:** *If you don't have counter 24h, you can identify the AM or PM with the date or day jump.*

---

## SETTING THE DATE

①

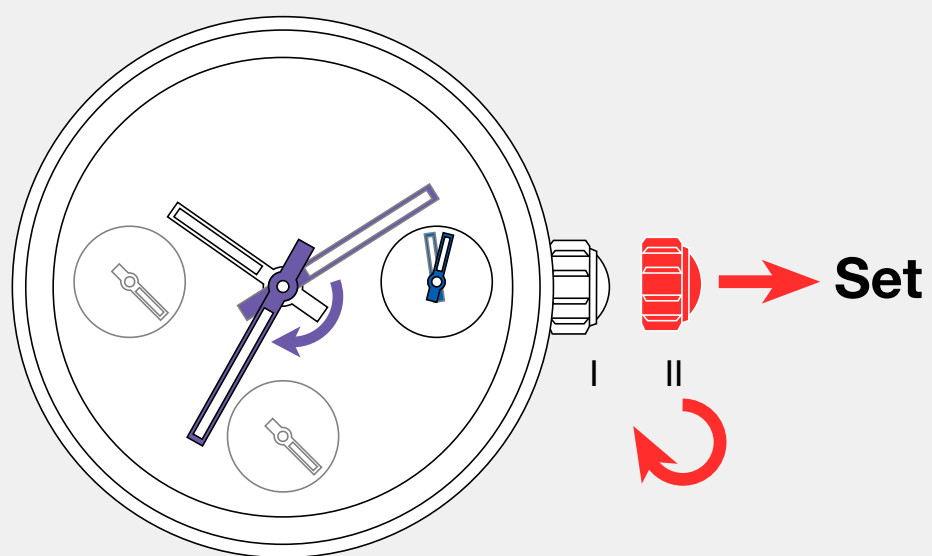

Pull the stem in pos. II

②

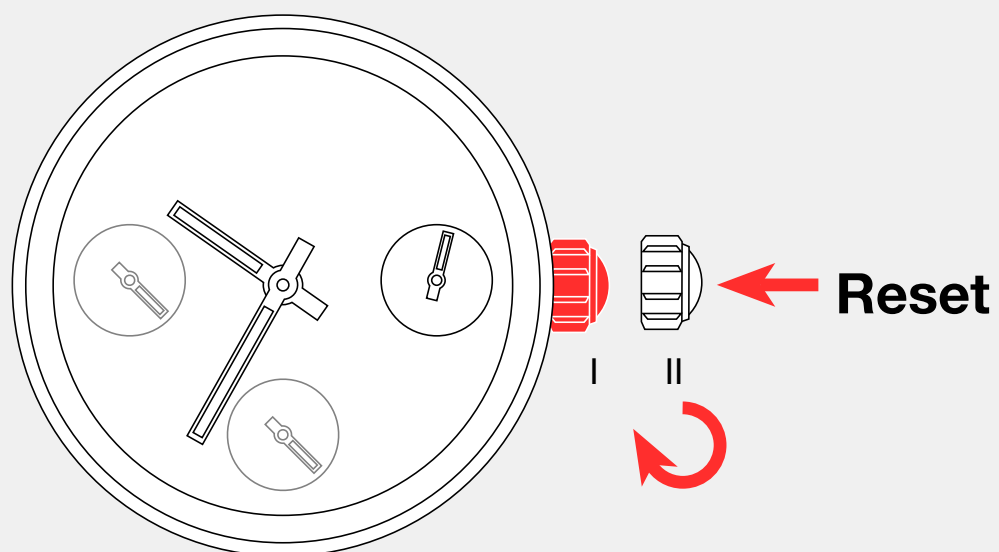

Push the stem in pos. I

## PRÉSENTATION

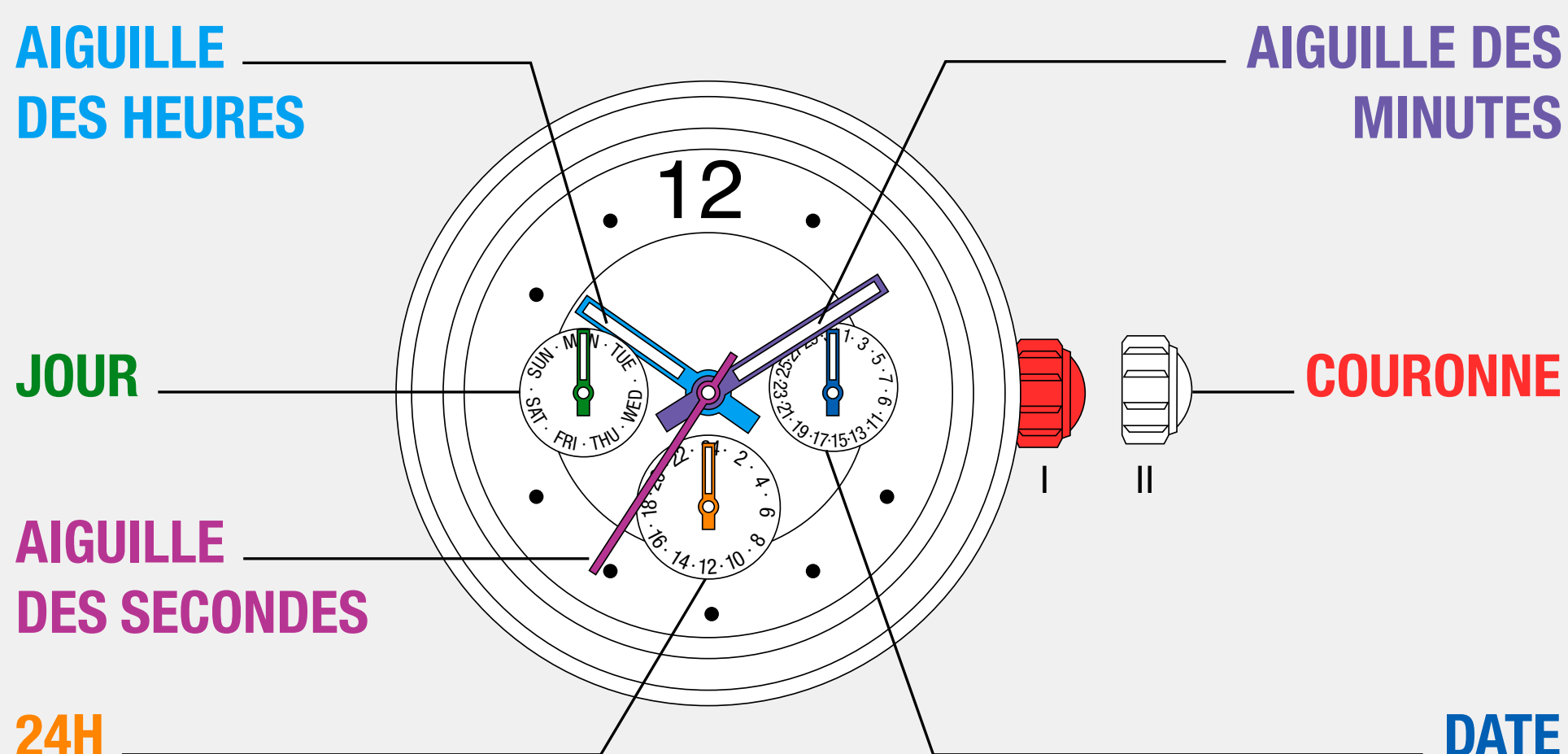

## SYNCHRONISER LE JOUR ET LA DATE

## ① Réglage de la date

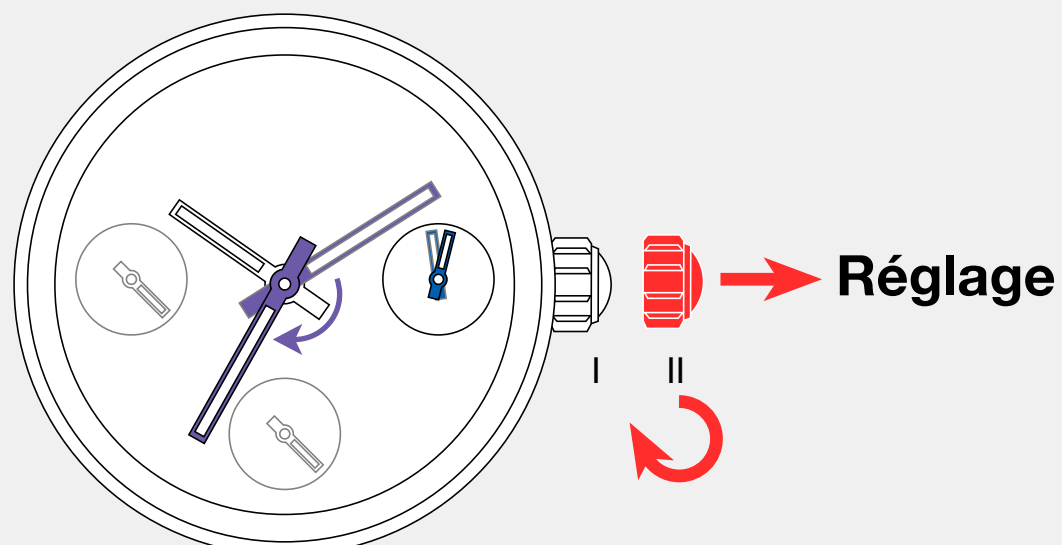

Tirez la tige en position II  
Tournez la couronne dans le sens horaire pour mettre à la date souhaitée.

**Commentaire :** La date ne change pas dans l'autre sens. Donc, lors du passage à la nouvelle date, vous pouvez aller à entre 22h et 2h jusqu'à la date souhaitée.

## ② Réglage de l'heure

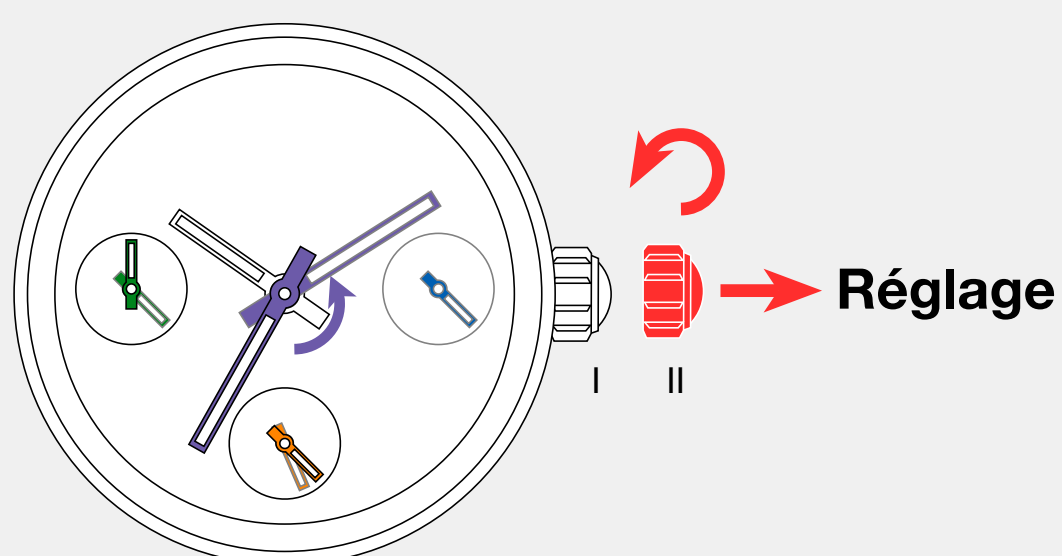

Tournez la couronne dans le sens antihoraire pour mettre au jour souhaité.

**Avertissement :** Respectez le tour antihoraire sur 24h selon que vous êtes le matin ou l'après-midi. Si vous n'avez pas le tour antihoraire sur 24 heures, vous pouvez savoir que vous êtes le matin ou l'après midi grâce au passage au jour suivant.

## ③ Réglage de l'heure et des 24h

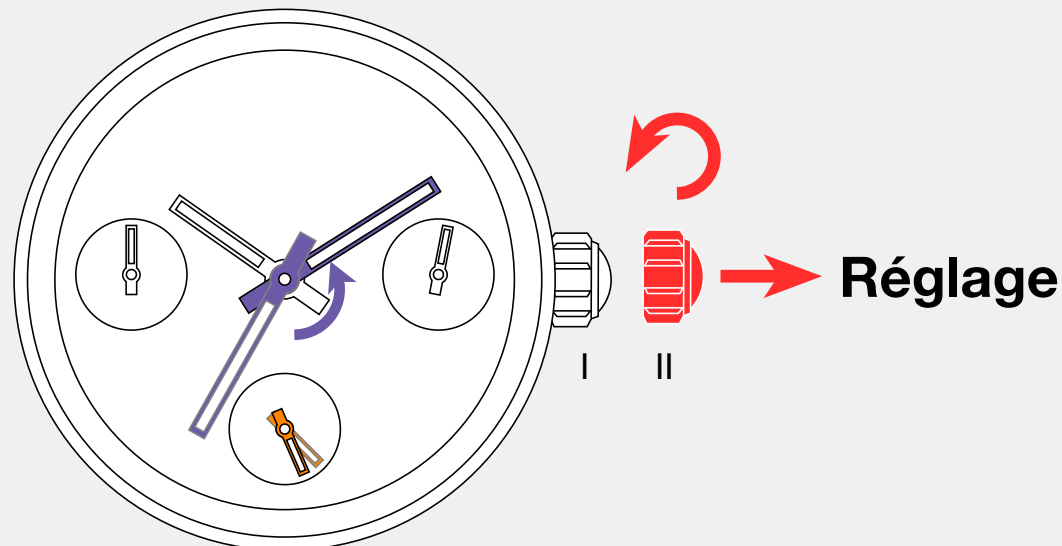

Tournez la couronne dans le sens antihoraire pour mettre à l'heure souhaitée.

**Commentaire:** Vous devez respecter la règle du tour unique (12h) si vous ne voulez pas changer le jour ou la date.

## ④

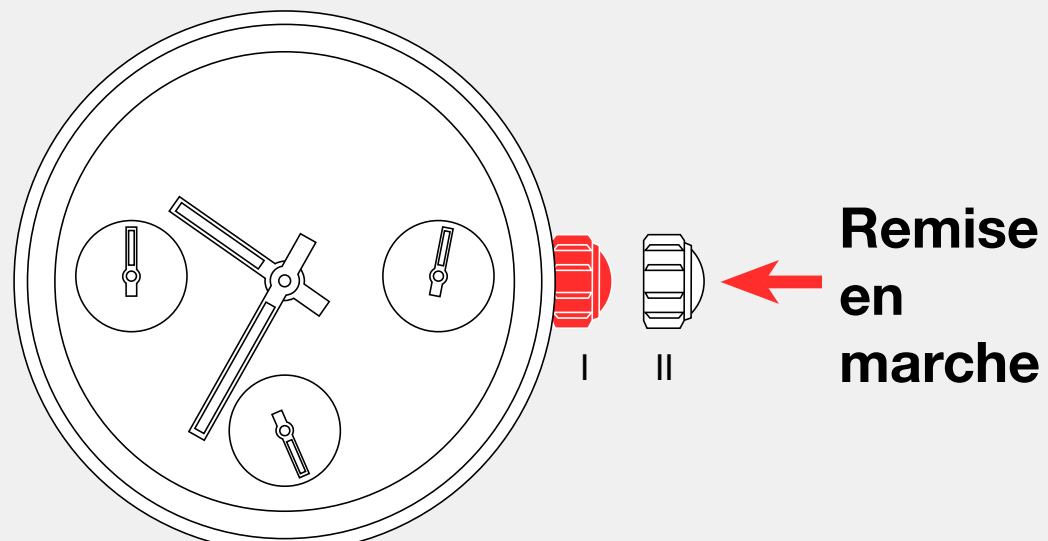

Poussez la tige en position I

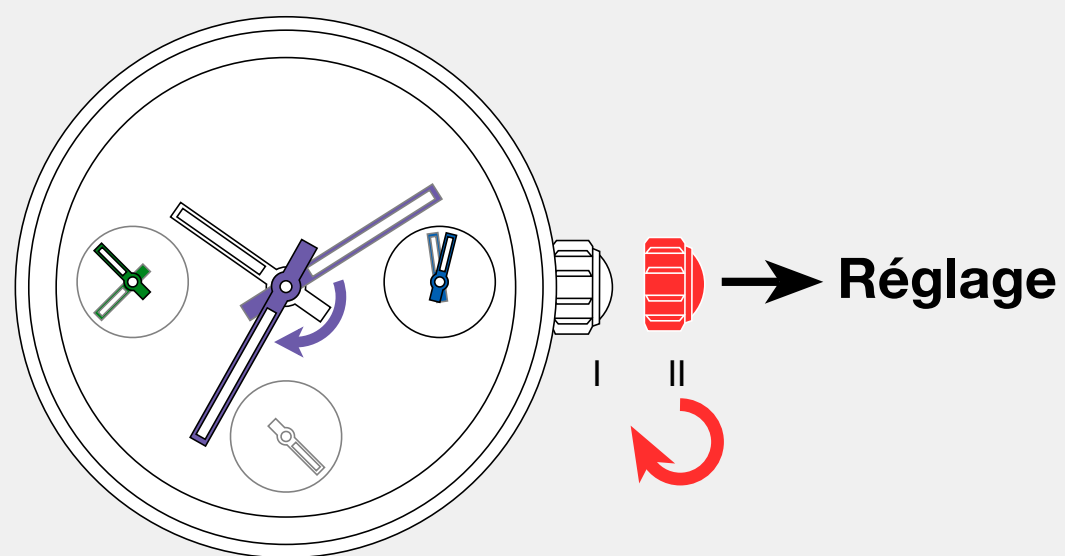

**EXEMPLE Vendredi 30 -> Samedi 1<sup>er</sup>****1**

Tirez la tige en position II.

Nous sommes le vendredi 30.

Tournez la couronne dans le sens horaire

(2 x 24 h) pour mettre la date au 1<sup>er</sup>.

En principe, le jour est le dimanche.

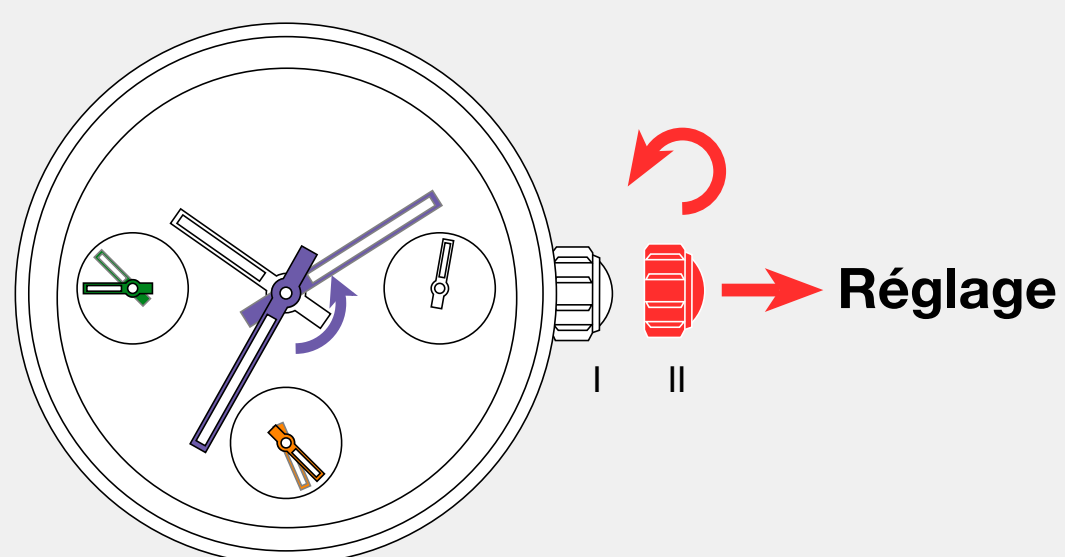
**2**

Nous sommes le dimanche 1<sup>er</sup>.

Tournez la couronne dans le sens

antihoraire (1 x 24h) pour mettre la date

au samedi.

**Commentaire:** La date ne change pas dans le sens antihoraire.

**Avertissement :** Respectez le tour antihoraire sur 24 heures selon que vous êtes le matin ou l'après-midi. Si vous n'avez pas le tour antihoraire sur 24 heures vous pouvez savoir que vous êtes le matin ou l'après-midi grâce au passage au jour suivant.

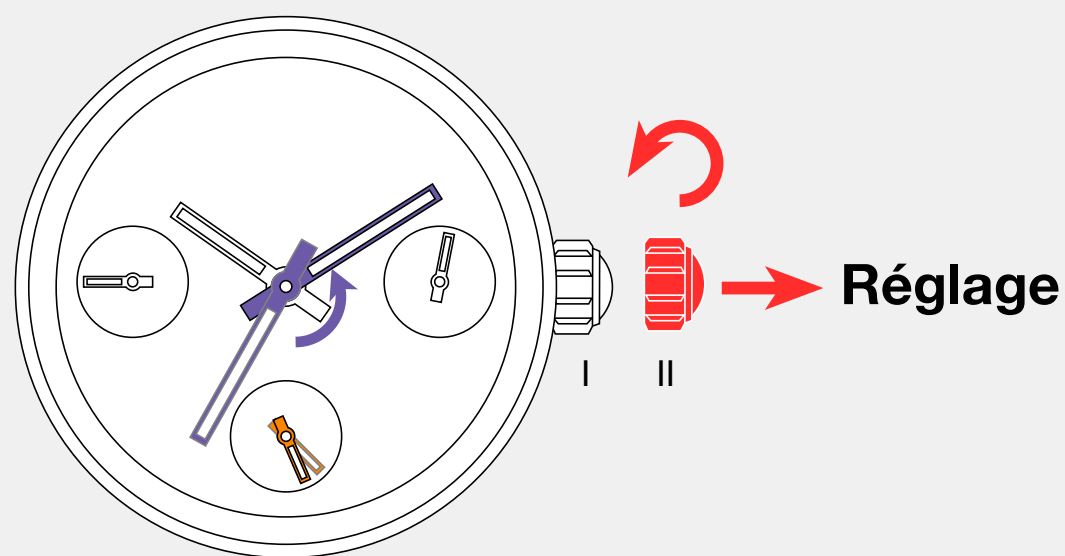
**3**

Tournez la couronne dans le sens

antihoraire pour mettre à la date

souhaitée.

**Commentaire:** Vous devez respecter la règle du tour unique (12 h) si vous ne voulez pas changer le jour ou la date.

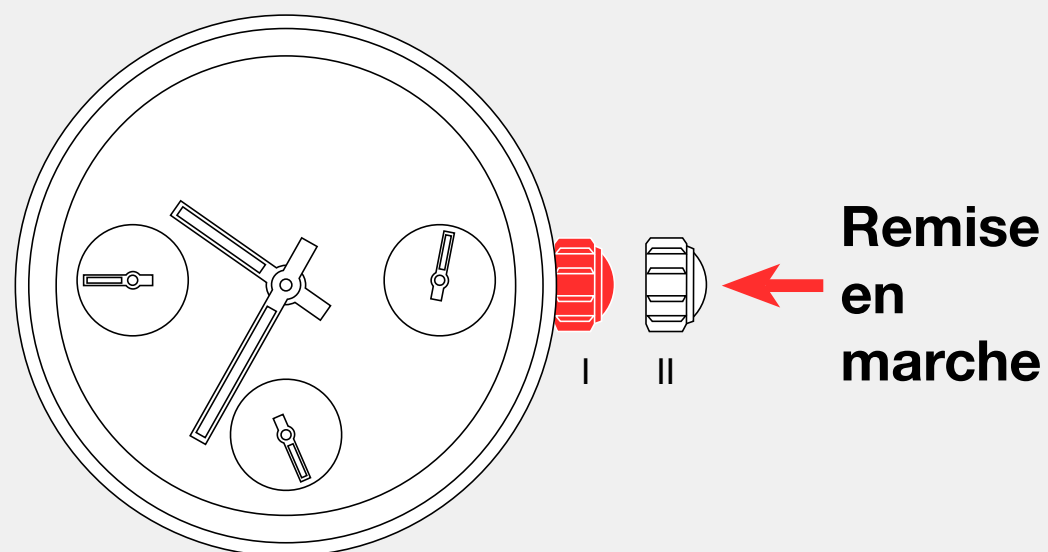
**4**

Poussez la tige en position I



## REGLAGE DE L'HEURE ET DES MINUTES

①

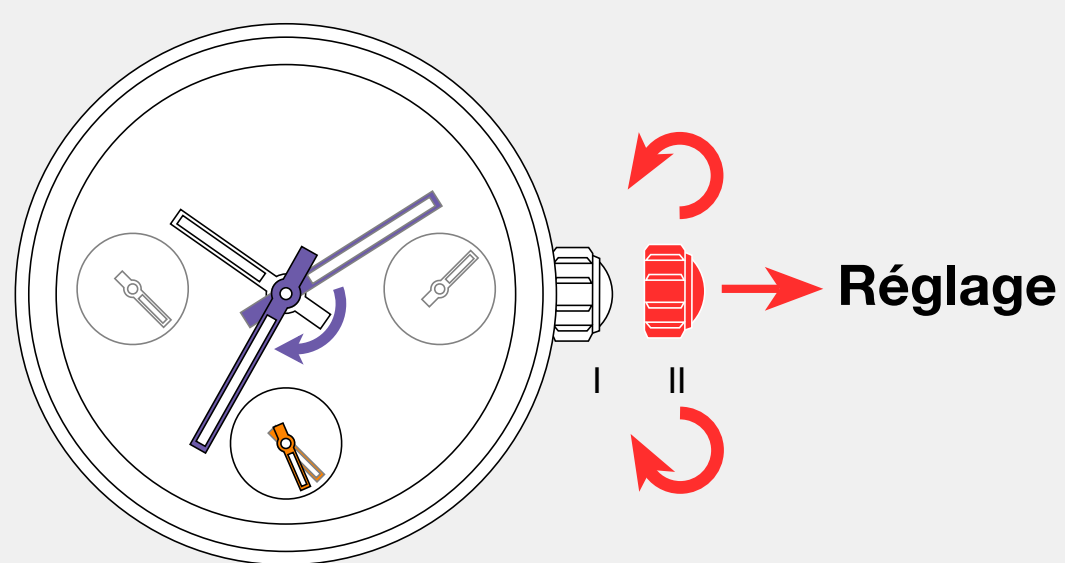

Poussez la tige en position II

**Avertissement :** Respectez le tour antihoraire sur 24h selon que vous êtes le matin ou le soir.

②

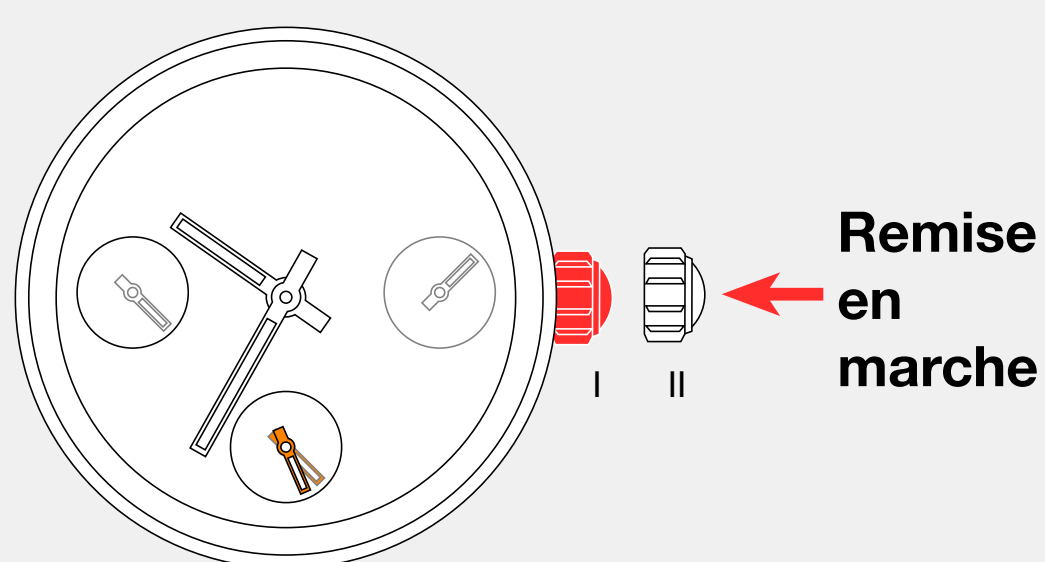

Poussez la tige en position. I

**Commentaire:** Si vous n'avez pas le tour antihoraire sur 24h, vous pouvez savoir si vous êtes le matin ou l'après-midi grâce à la date ou le passage au jour suivant.

---

## CORRECTION DE LA DATE

①

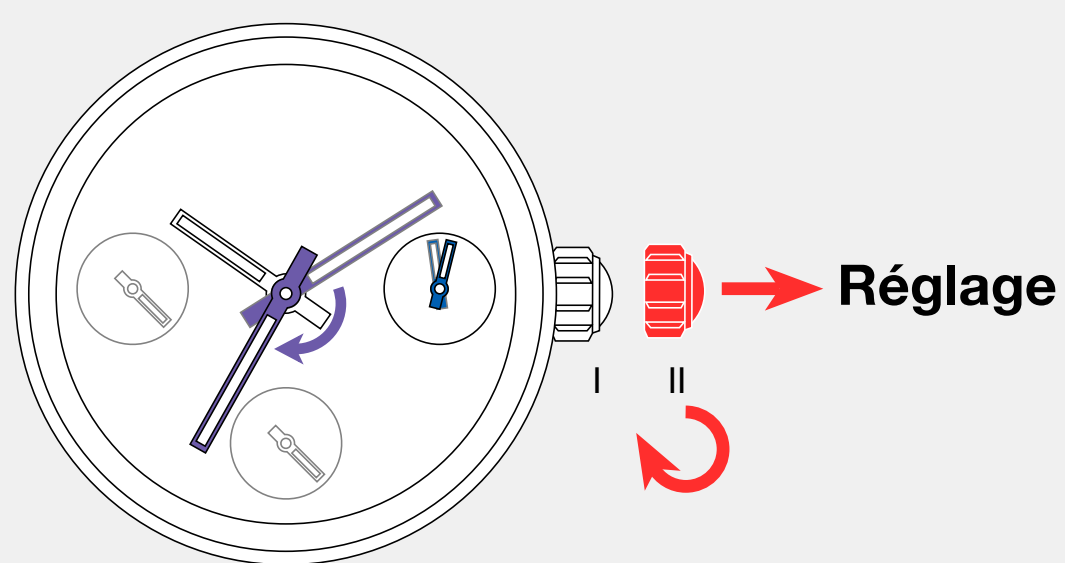

Tirez la tige en position II

②

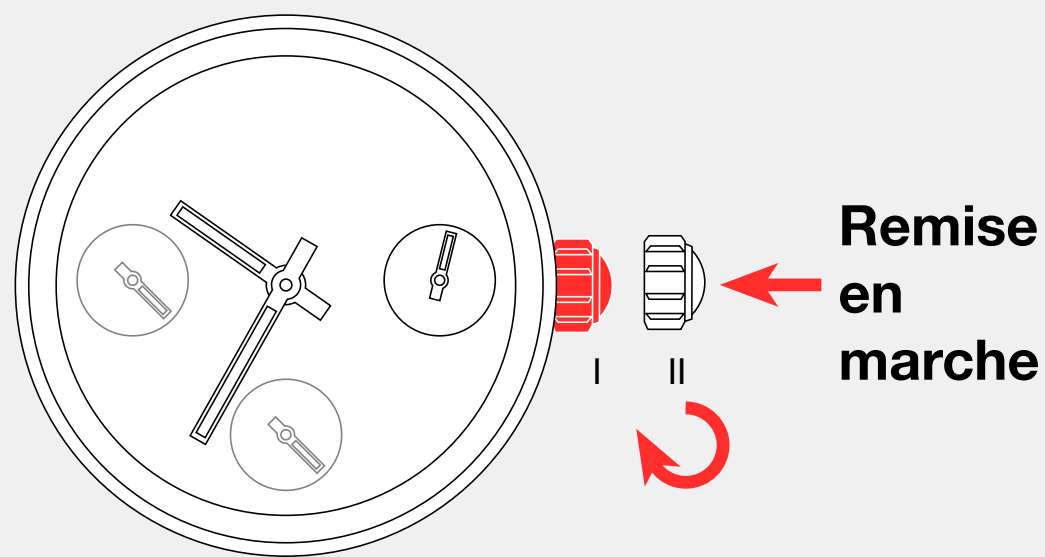

Poussez la tige en position I



## ANSICHT

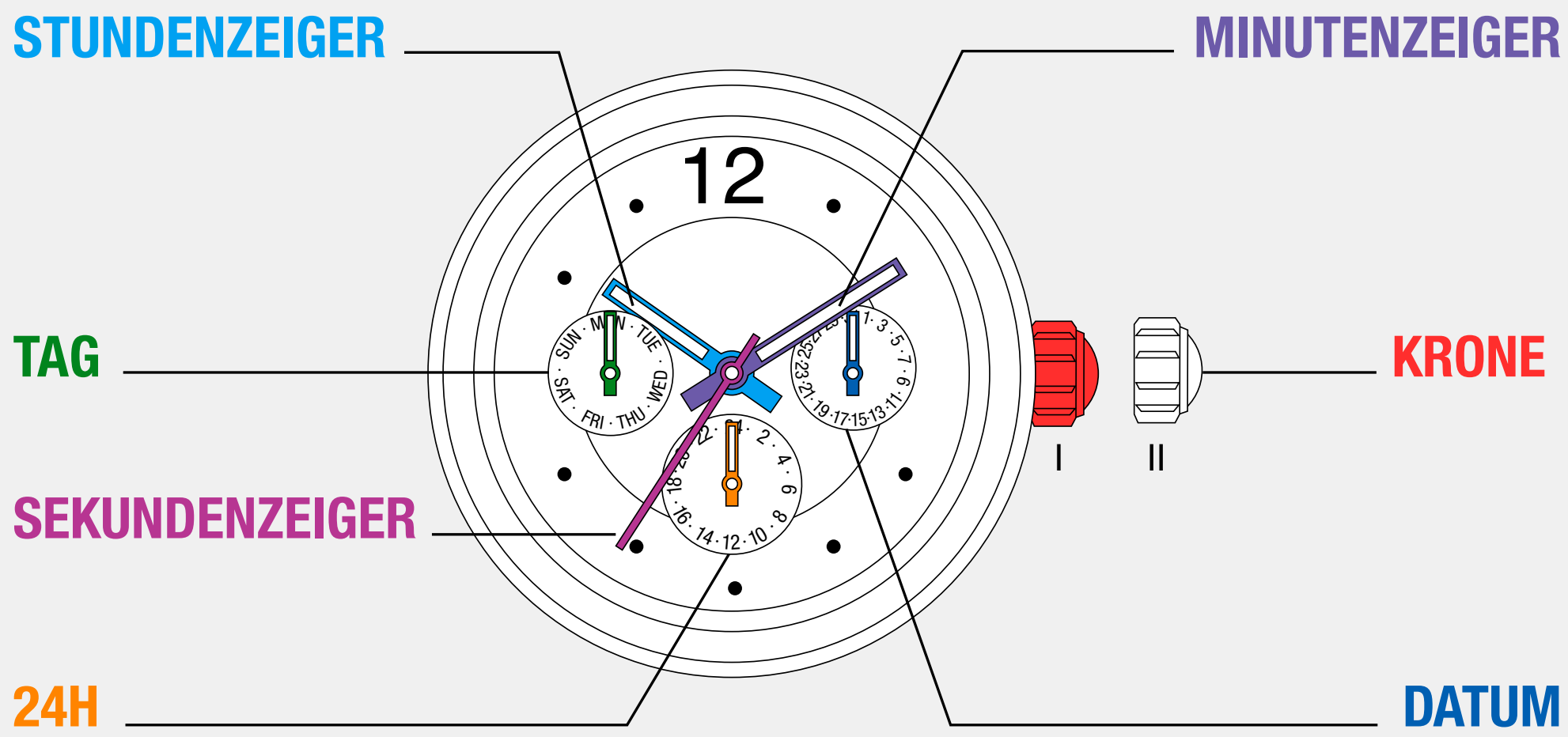

## SYNCHRONISIEREN TAG UND DATUM

1

### Datum einstellen

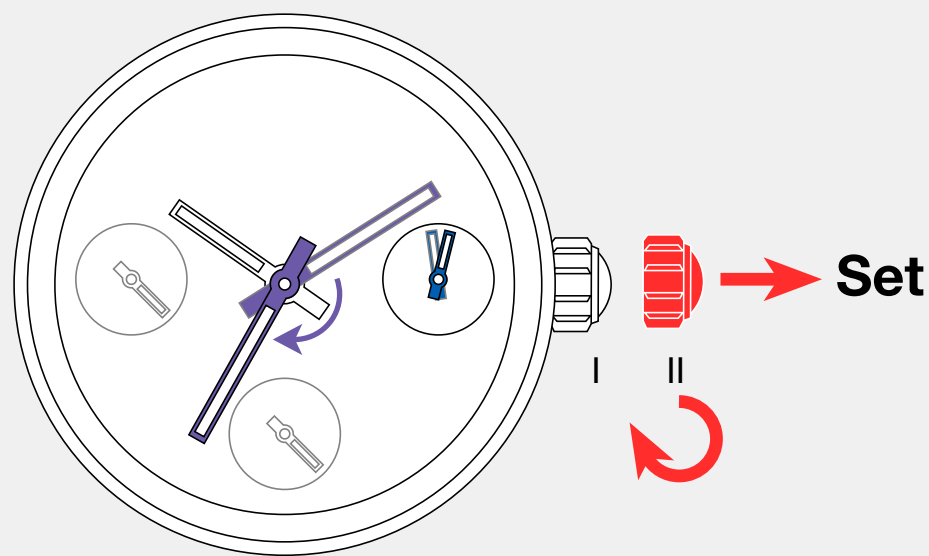

Krone in Pos. II ziehen  
Krone im Uhrzeigersinn drehen,  
um das gewünschte Datum einzustellen

**Kommentar:** Das Datum springt nicht in die andere Richtung. Ist das Datum umgesprungen, mit einem Rundlauf zwischen 22 h und 2 h das gewünschte Datum einstellen.

2

### Tag einstellen

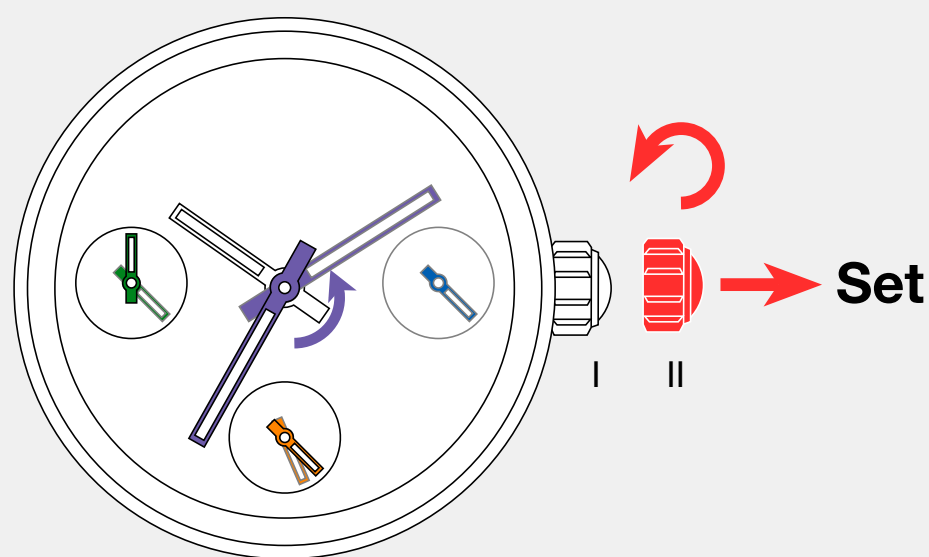

Krone gegen den Uhrzeigersinn drehen,  
um den gewünschten Tag einzustellen.

**Warnung:** 24-Stunden-Funktion beachten. Wenn die 24-Stunden-Funktion nicht aktiviert ist, kann Vormittag/Nachmittag am Umspringen des Tages identifiziert werden.

3

### Stunden und 24-Stunden-Funktion einstellen

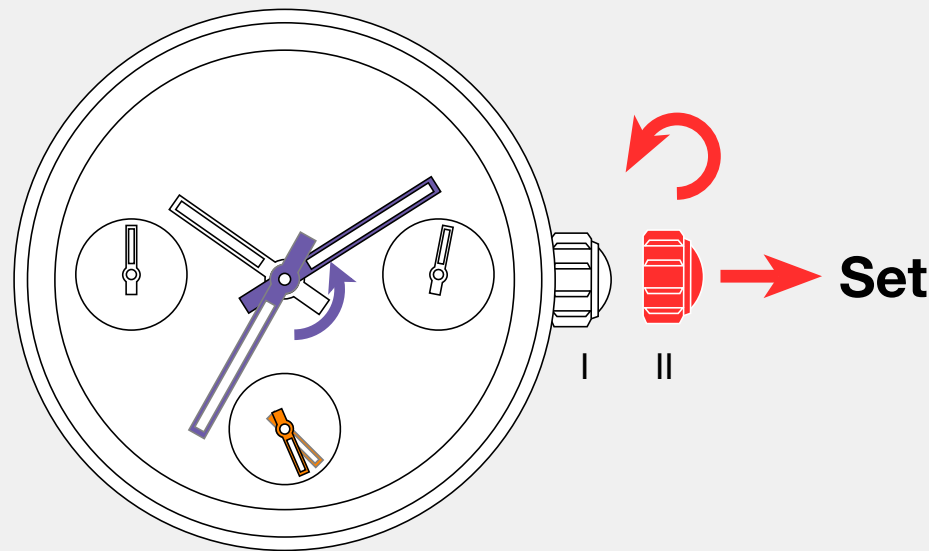

Krone gegen den Uhrzeigersinn drehen,  
um die gewünschte Stunde einzustellen.

**Kommentar:** Wenn Tag bzw. Datum erhalten bleiben sollen, nur eine Umdrehung (12 Std.) durchführen.

4

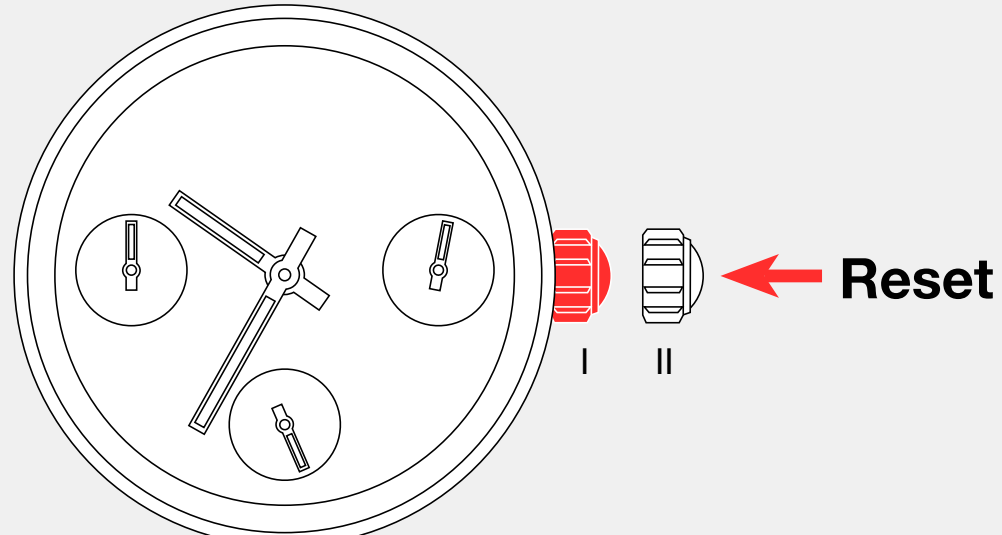

RESET Krone in Pos. I ziehen



# BEISPIEL Freitag 30 -> Samstag 1

1

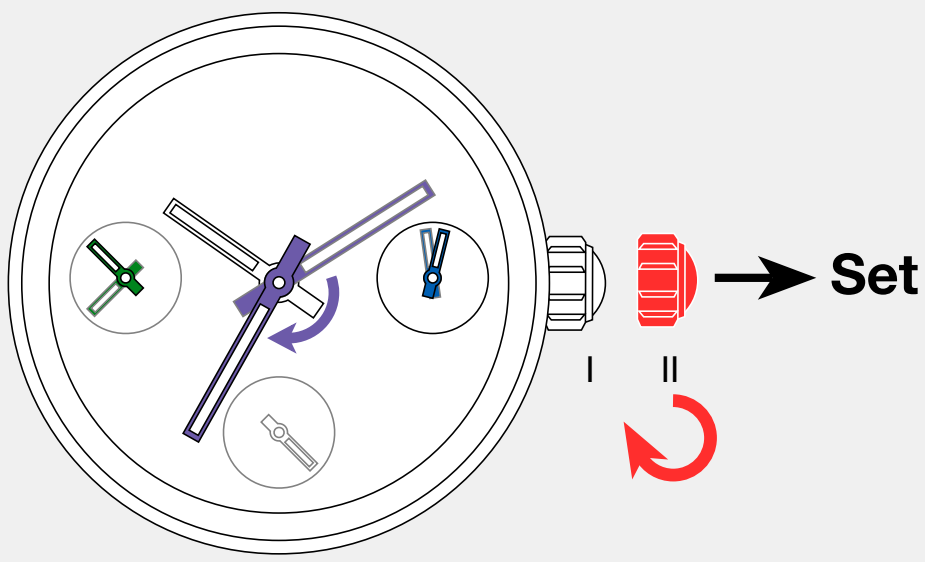

Krone in Pos. II ziehen  
Heute ist Freitag, der 30.  
Krone im Uhrzeigersinn drehen (2x24 Std.),  
um den Monatsersten einzustellen. Dieser  
Tag ist der Sonntag.

2

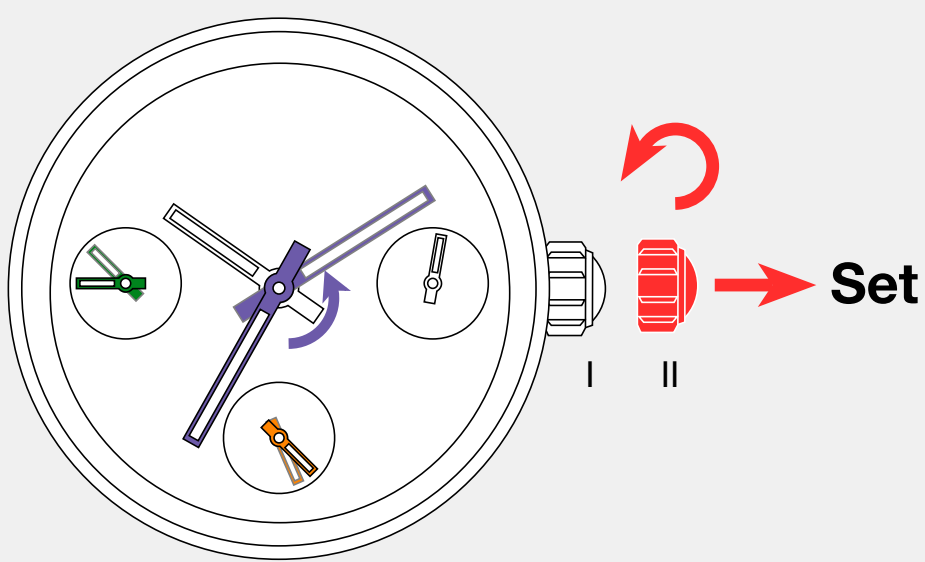

Heute ist Sonntag, der 1.  
Krone gegen den Uhrzeigersinn drehen  
(1x24 Std.), um den Tag auf Samstag  
einzustellen.

**Kommentar:** *Das Datum springt nicht  
gegen den Uhrzeigersinn.*

**Warnung:** *24-Stunden-Funktion  
beachten. Wenn die 24-Stunden-  
Funktion nicht aktiviert ist, kann  
Vormittag/Nachmittag am Umspringen  
des Tages identifiziert werden.*

3

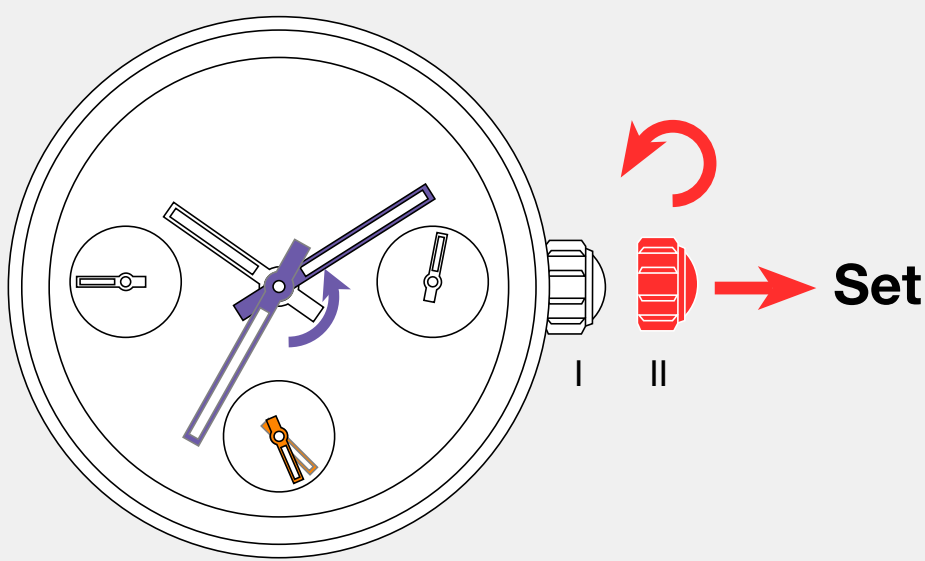

Krone gegen den Uhrzeigersinn drehen,  
um die gewünschte Stunde einzustellen.

**Kommentar:** *Wenn Tag bzw. Datum  
erhalten bleiben sollen, nur eine  
Umdrehung (12 Std.) durchführen.*

4

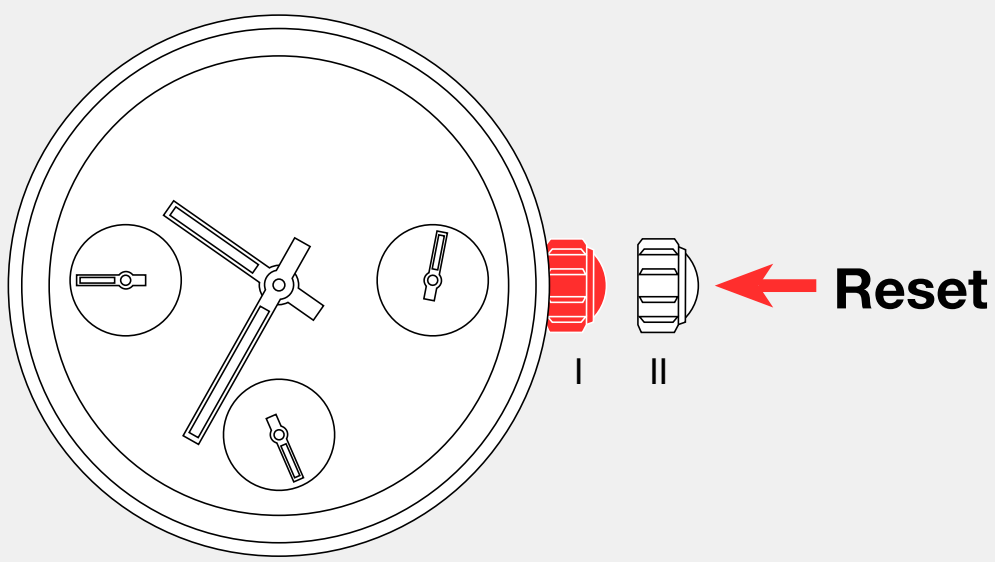

Krone in Pos. I drücken



# EINSTELLEN DER ZEITANZEIGE STUNDEN UND MINUTEN

1

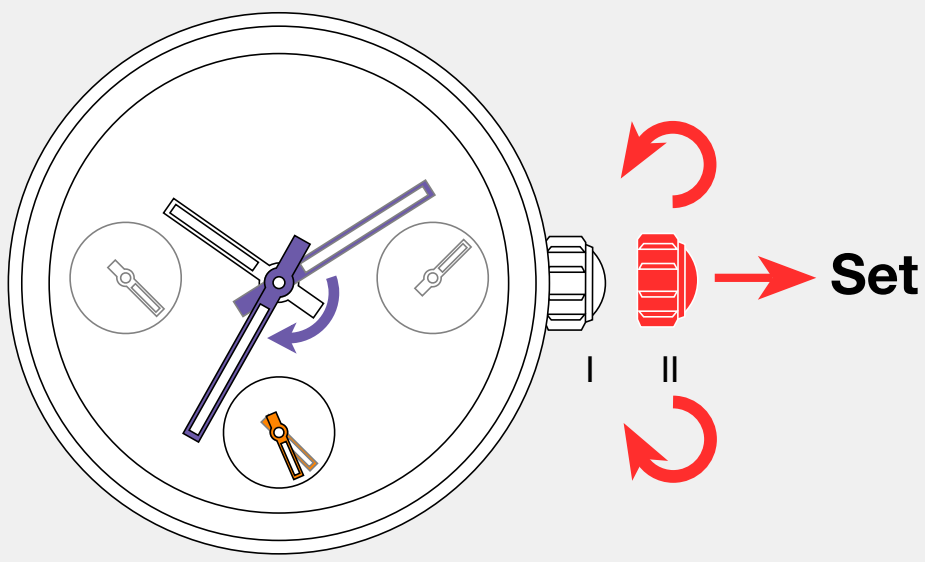

Krone in Pos. II ziehen

**Warnung:** 24-Stunden-Funktion beachten

2

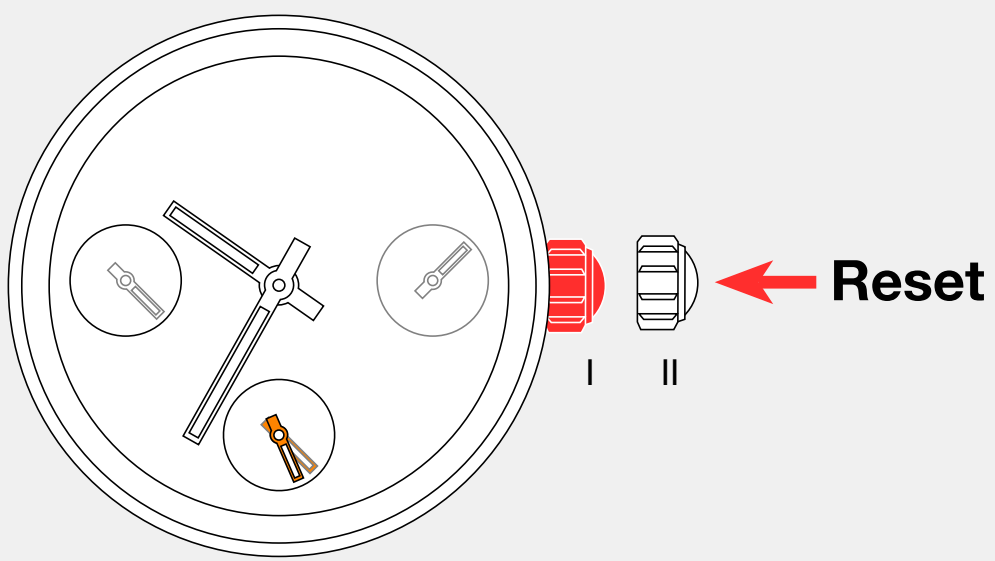

Krone in Pos. I drücken

**Kommentar:** Wenn die 24-Stunden-Funktion nicht aktiviert ist, kann Vormittag/Nachmittag am Umspringen des Tages identifiziert werden.

---

# DATUMSEINSTELLUNG

1

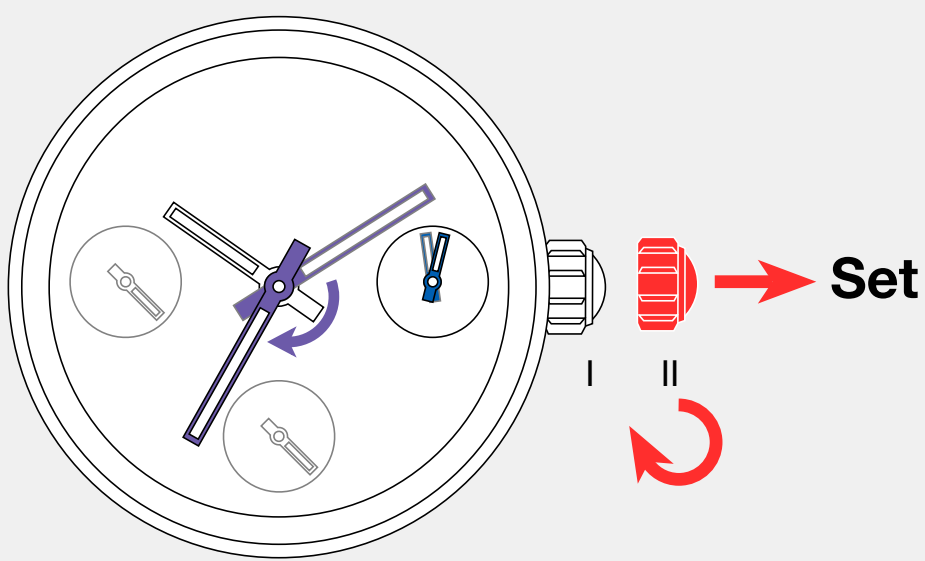

Krone in Pos. II ziehen

2

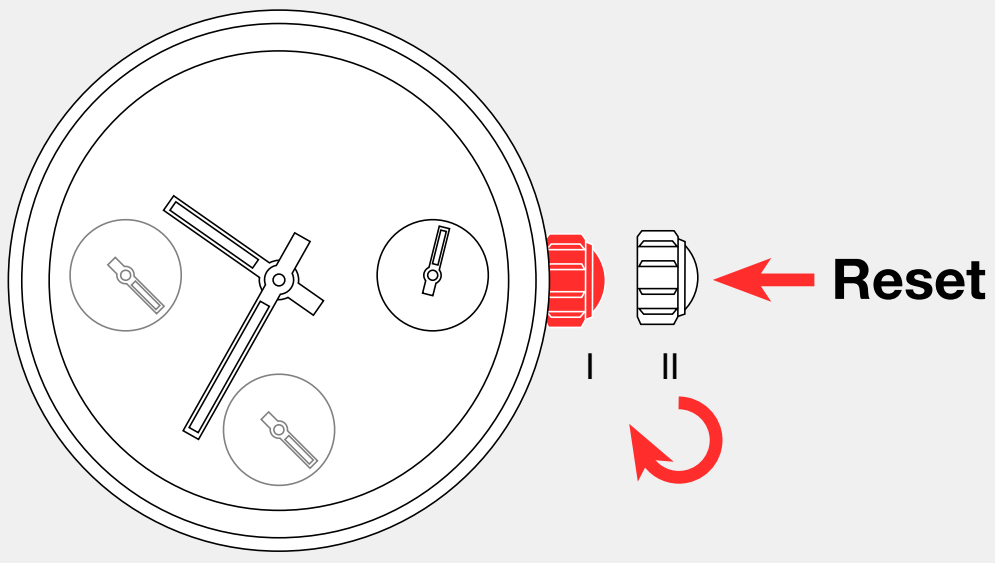

Krone in Pos. I drücken



## APRESENTAÇÃO

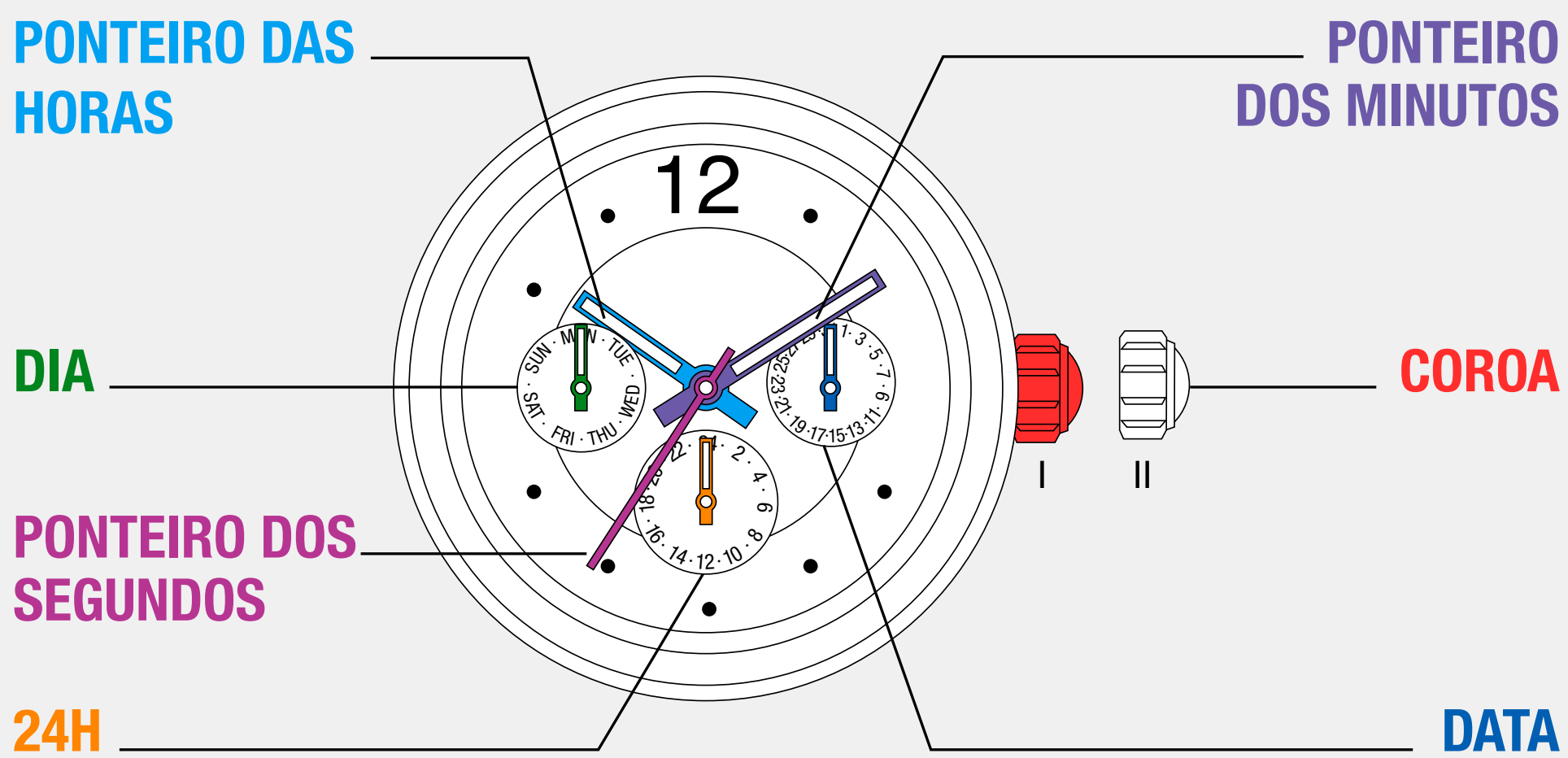

## SINCRONIZAR DIA E DATA

### 1 Configurar a data

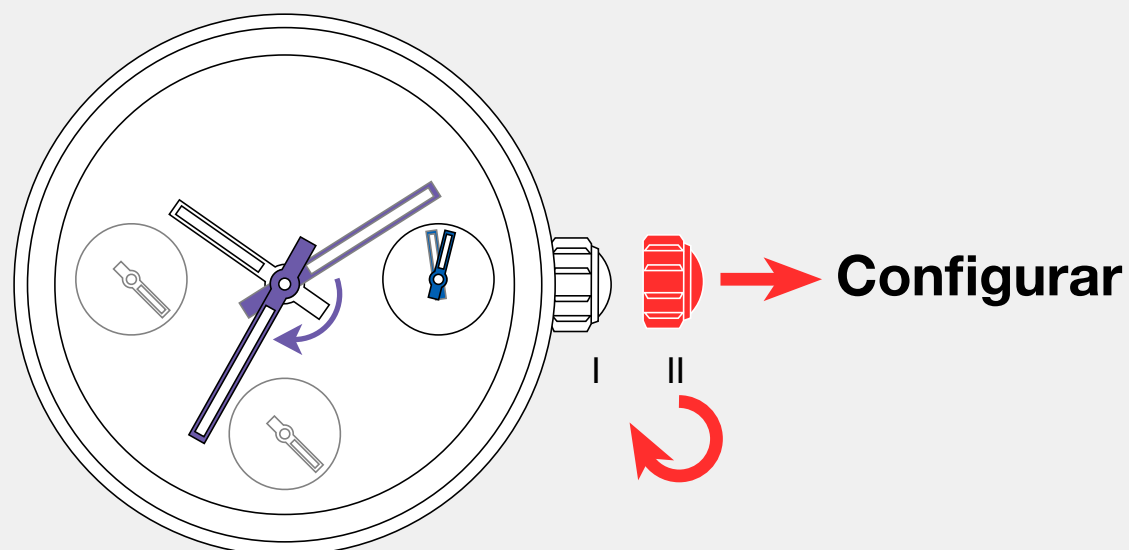

Coloque o botão na pos. II  
Rode a coroa no sentido dos ponteiros para ajustar a data desejada

**Comentário:** A data não se altera na direção contrária. Por isso, se passar a data desejada, pode dar uma volta completa entre as 22 h e as 2 h, até à data desejada.

### 2 Configurar o dia

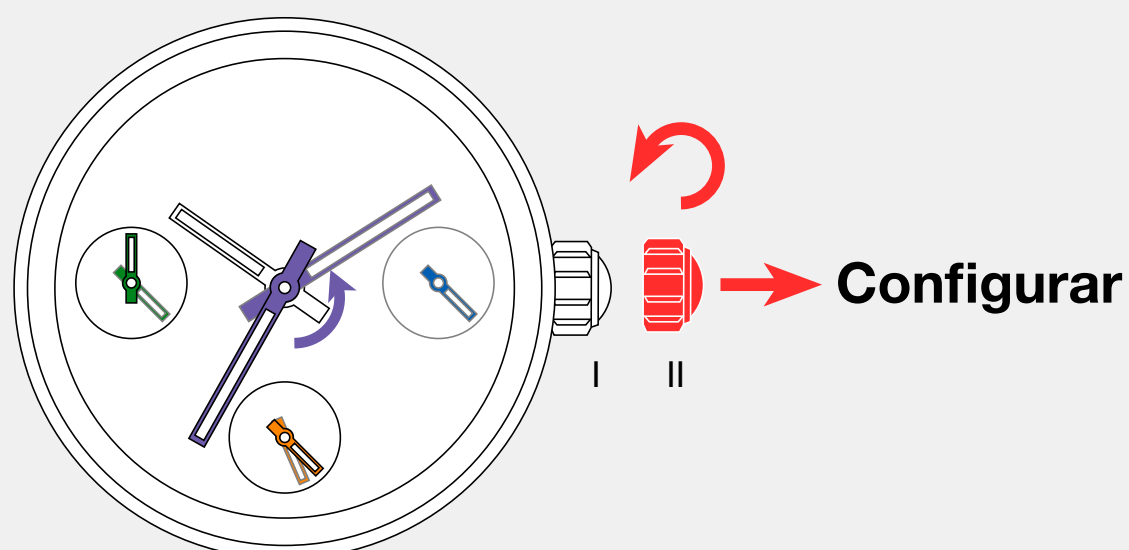

Rode a coroa no sentido contrário ao dos ponteiros para ajustar o dia desejado

**Atenção:** Observe o contador de 24h para ver se está em AM ou PM  
Se não possuir o contador de 24h, pode identificar se está em AM ou PM através do salto de um dia.

### 3 Configurar a hora e 24 h

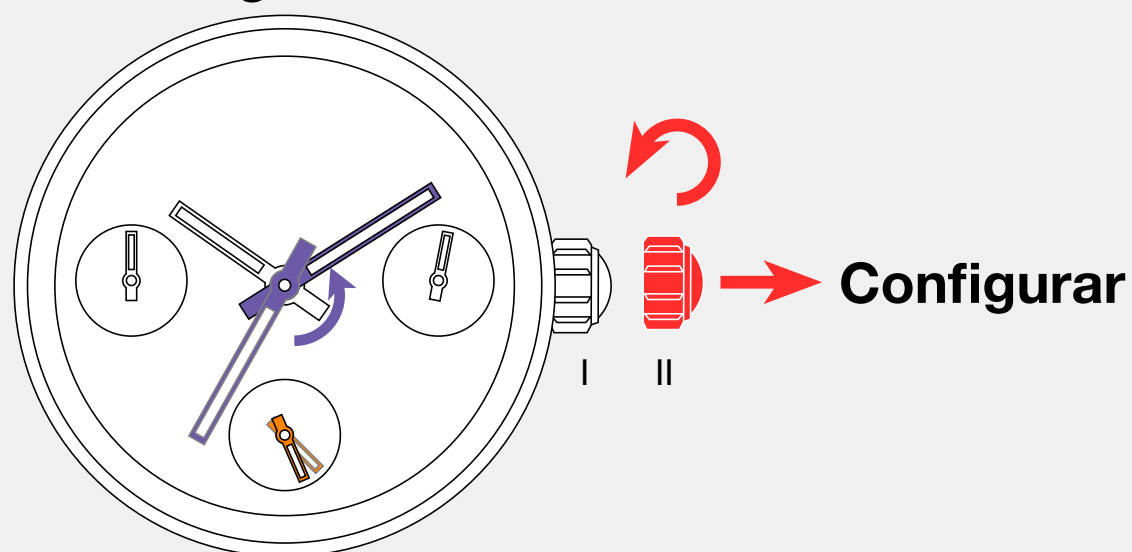

Rode a coroa no sentido contrário ao dos ponteiros para ajustar a hora desejada.

**Comentário:** Apenas deve observar 1 volta (12h) se não pretende alterar o dia ou a data.

### 4

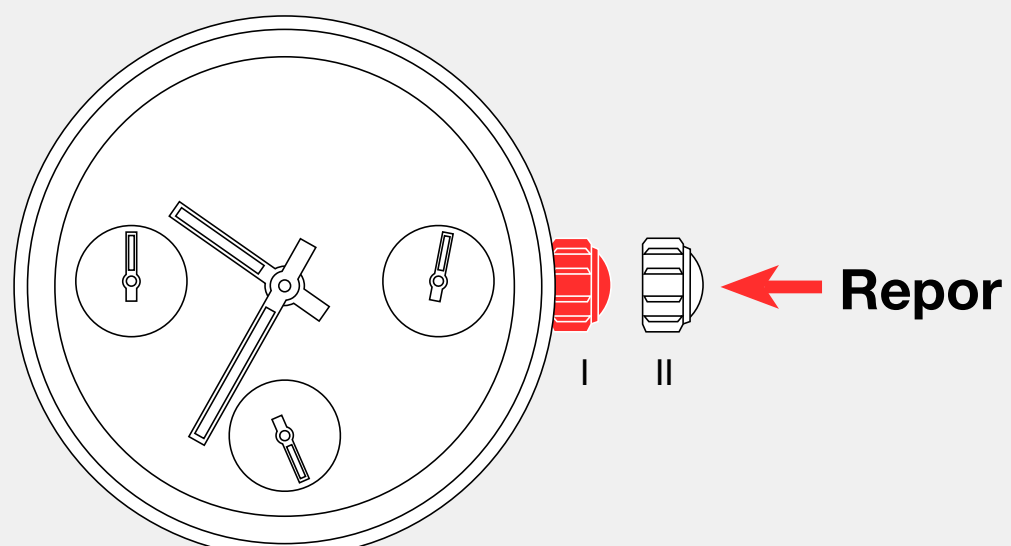

Coloque o botão na pos. I

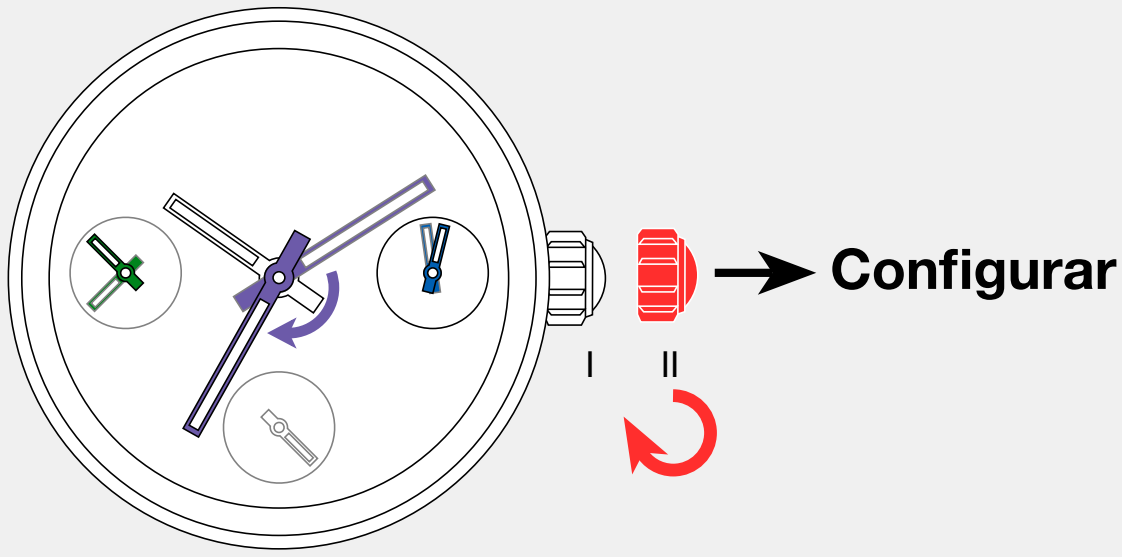
**EXEMPLO sexta-feira, 30 -> sábado, 1****1**

Coloque o botão na pos. II.  
É sexta-feira, dia 30.  
Rode a coroa no sentido dos ponteiros (2x24 h) para ajustar a data para o dia 1.  
Normalmente, o dia está em domingo.

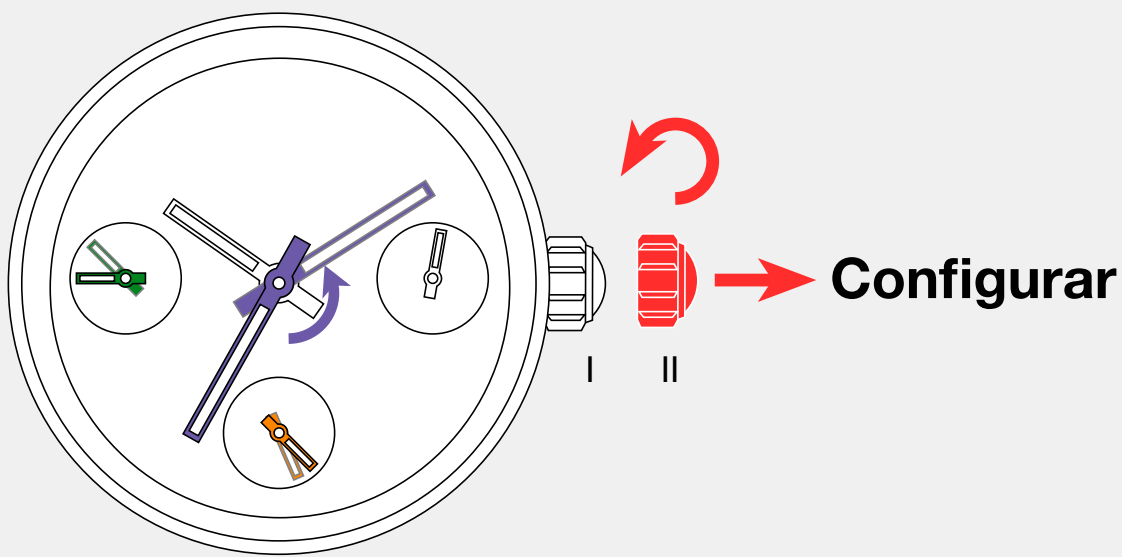
**2**

É domingo, dia 1.  
Rode a coroa no sentido contrário ao dos ponteiros (1x24 h) para ajustar o dia para sábado.

**Comentário:** A data não se altera na direção contrária. Atenção: Observe o contador de 24h para ver se está em AM ou PM. Se não possuir o contador de 24h, pode identificar se está em AM ou PM através do salto de um dia.

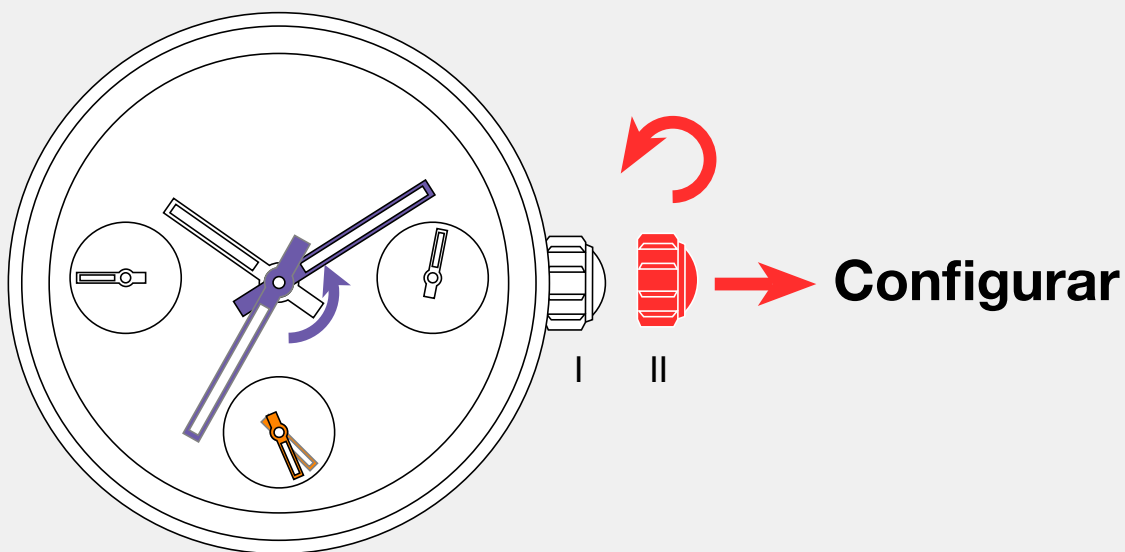
**3**

Rode a coroa no sentido contrário ao dos ponteiros para ajustar a hora desejada.

**Comentário:** Apenas deve observar 1 volta (12h) se não pretende alterar o dia ou a data.

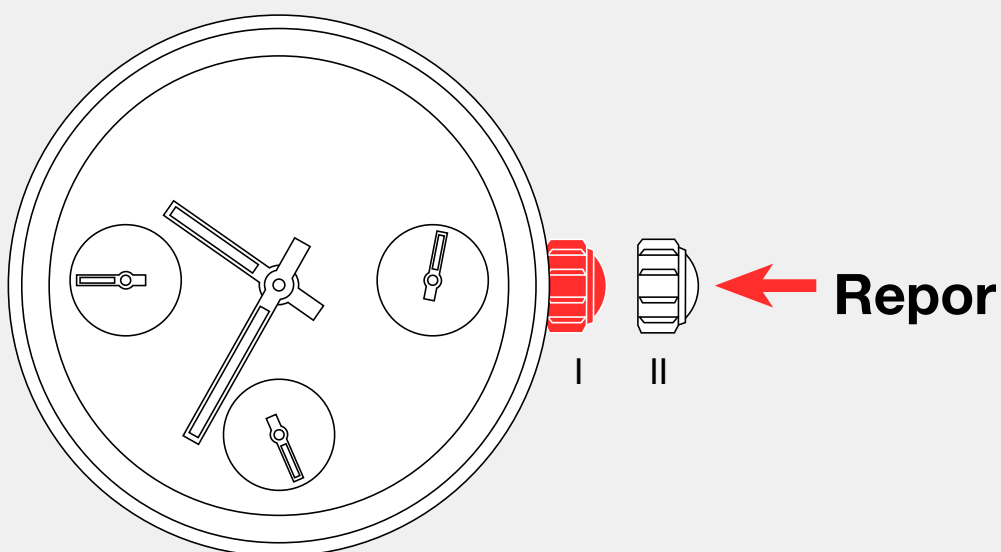
**4**

Coloque o botão na pos. I

## CONFIGURAR A HORA (HORA E MINUTOS)

①

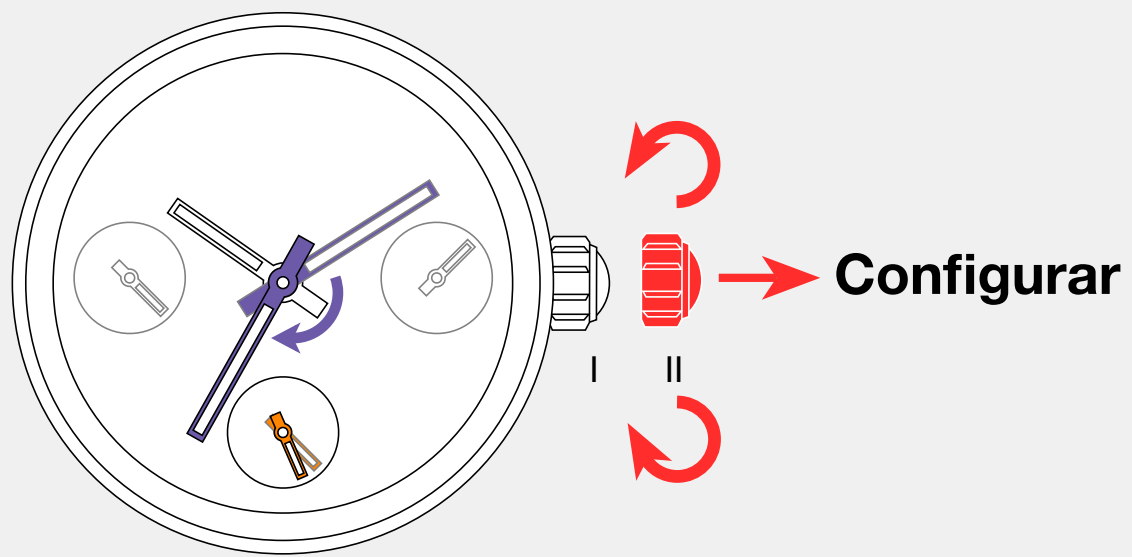

Coloque o botão na pos. II

**Atenção:** Observe o contador de 24h para ver se está em AM ou PM

②

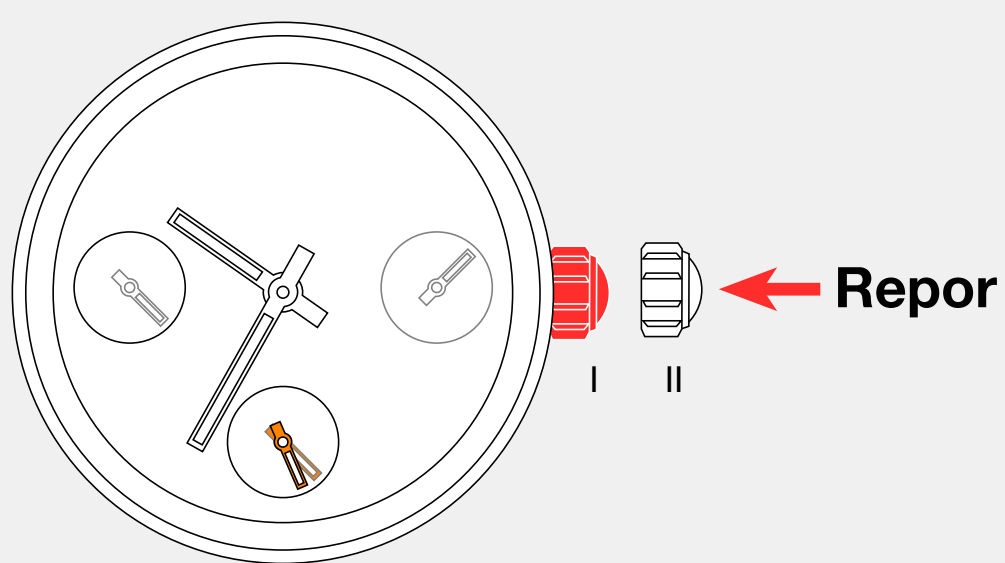

Coloque o botão na pos. I

**Comentário:** Se não possuir o contador de 24h, pode identificar se está em AM ou PM através do salto da data ou de um dia.

---

## AJUSTE DA DATA

①

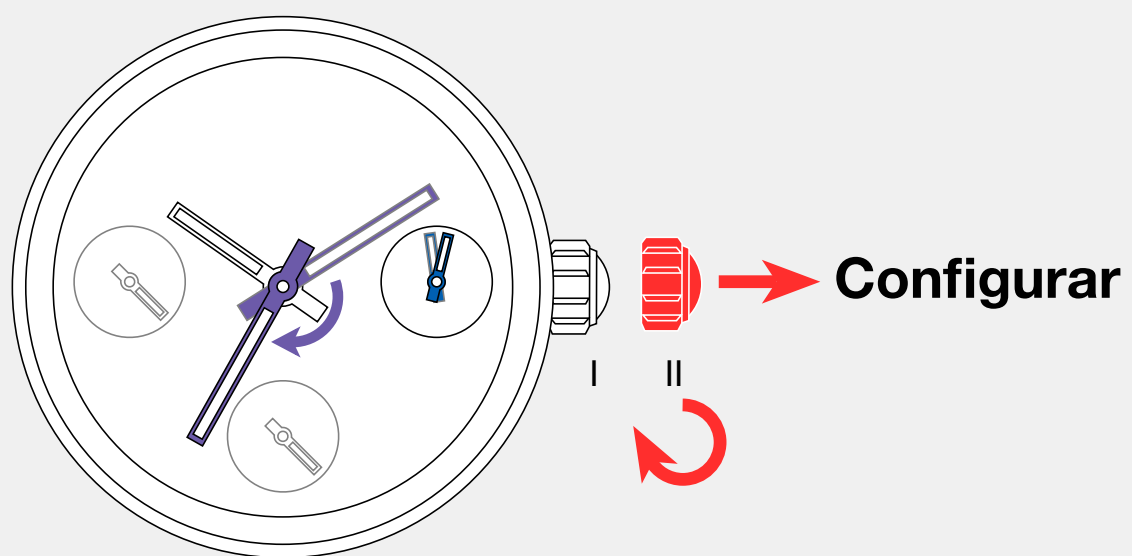

Coloque o botão na pos. II

②

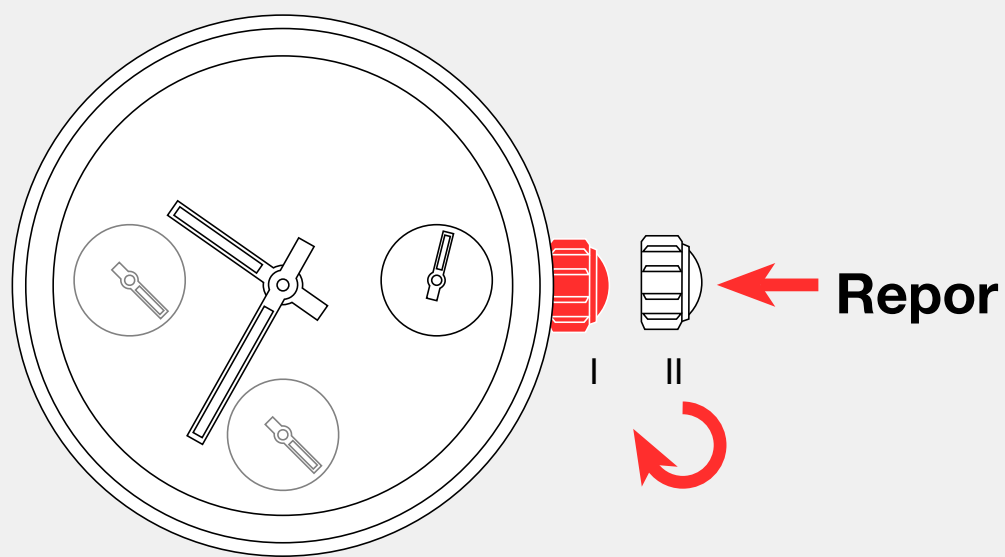

Coloque o botão na pos. I